

GB**F Standard Sprinkler Finish:**

- 0 Plain Stainless Steel 316
- 1 Plain Brass
- 3 White Polyester RAL9010
- 4 Bright White Polyester
- 6 Wax Coated
- 9 Chrome Plated



Refers to detailed technical datasheet. Available on request.



Sprinkler Wrench to use.
Refers to the relevant page number in catalog.



Sprinkler can also be used in recessed application.
Refers to the relevant page number in catalog.

RU**F Стандартное покрытие спринклеров:**

- 0 Нержавеющая углеродистая сталь 316
- 1 Латунь
- 3 Белый полиэфир RAL9010
- 4 Ярко-белый полиэфир
- 6 Покрытие из воска
- 9 С хромовым покрытием



Ссылка на подробную техническую спецификацию. Предоставляется по запросу.



Используемый спринклерный ключ.
Ссылка на соответствующий номер страницы в каталоге.



Спринклер также может углубляться.
Ссылка на соответствующий номер страницы в каталоге.

TR**F Standart sprinkler kaplamaları:**

- 0 Düz paslanmaz çelik 316
- 1 Düz pirinç
- 3 Beyaz Polyester RAL9010
- 4 Parlak beyaz Polyester
- 6 Mum kaplamalı
- 9 Krom kaplamalı



Teferruatlı teknik veri dosyasına gönderir. İstek üzere tedarik edilir.











Sprinkler anahtarı kullanılmalıdır. Katalogdaki ilgili sayfaya gönderir.



Sprinklerler gömmeli olarak da kullanılabilir. Katalogdaki ilgili sayfaya gönderir.

RU Спринклеры, насадки и аксессуары

TR Sprinklerler, nozullar ve aksesuarlar

	Standard Coverage Sprinklers Спринклеры со стандартной зоной орошения Normal kaplama alanlı sprinklerler	P. 1.003
	Extended Coverage Sprinklers Спринклеры с расширенной зоной орошения Genişletilmiş kaplama alanlı sprinklerler	P. 1.027
	Storage Sprinklers Спринклеры для складских помещений Depo tipi sprinklerler	P. 1.037
	Residential Sprinklers Спринклеры для жилых помещений Konut Tipi sprinklerler	P. 1.053
	Dry Sprinklers Спринклеры сухого типа Kuru borulu (soguk odalar icin) sprinklerler	P. 1.058
	Special Sprinklers & Multiple Jet Controls Спринклеры специального назначения и многоструйные оросители Özel sprinklerler ve kontrol sprinklerler	P. 1.067
	Nozzles Насадки Nozullar	P. 1.084
	Sprinkler Accessories Принадлежности для спринклеров Sprinkler aksesuarlar	P. 1.100

Standard Coverage Sprinklers

RU Спринклеры со стандартной зоной орошения

TR Normal kaplama alanlı sprinklerler



Standard Response, Upright

Стандартное реагирование, с вогнутой розеткой
Normal tepkili, yukarı bakan

P. 1.005



Standard Response, Upright [K=57]

Стандартное реагирование, с вогнутой розеткой [K=57]
Normal tepkili, yukarı bakan [K=57]

P. 1.006



Standard Response, Upright

Стандартное реагирование, с вогнутой розеткой
Normal tepkili, yukarı bakan

P. 1.007



TY-B

Standard Response, [Recessed] Pendent

Стандартное реагирование, [утопленные] с плоской розеткой
Normal tepkili, [gömme] aşağı bakan

P. 1.008



TY-B

Standard Response, Pendent [K=57]

Стандартное реагирование, с плоской розеткой [K=57]
Normal tepkili, aşağı bakan [K=57]

P. 1.009



TY-L

Standard Response, [Recessed] Pendent

Стандартное реагирование, [утопленные] с плоской розеткой
Normal tepkili, [gömme] aşağı bakan

P. 1.010



TY-B

Standard Response, Conventional

Стандартное реагирование, традиционные
Normal tepkili, konvansiyonel

P. 1.011



TY-B

Standard Response, [Recessed] Horizontal Sidewall

Стандартное реагирование, [утопленные] горизонтальные настенные
Normal tepkili, [gömme] yatay duvar tipi

P. 1.012



TY-L

Standard Response, Horizontal Sidewall

Стандартное реагирование, горизонтальные настенные
Normal tepkili, yatay duvar tipi

P. 1.013



TY-B

Standard Response, Vertical Sidewall

Стандартное реагирование, вертикальные настенные
Normal tepkili, dikey duvar tipi

P. 1.014



TY-B

Special Response, Upright

Особого реагирования, с вогнутой розеткой
Özel tepkili, yukarı bakan











P. 1.015

TYCERTFP 03/07 Tyco reserves the right to change the contents without notice

Standard Coverage Sprinklers

RU Спринклеры со стандартной зоной орошения

TR Normal kaplama alanlı sprinklerler

	Special Response, Pendent Особого реагирования, с плоской розеткой Özel tepkili, aşağı bakan	P. 1.016
TY-B		
	Special Response, Conventional Особого реагирования, традиционные Özel tepkili, konvansiyonel	P. 1.017
TY-B		
	Quick Response, Upright Быстрого реагирования, с вогнутой розеткой Hızlı tepkili, yukarı bakan	P. 1.018
TY-FRB		
	Quick Response, Upright Быстрого реагирования, с вогнутой розеткой Hızlı tepkili, yukarı bakan	P. 1.019
TY-FRL		
	Quick Response, [Recessed] Pendent Быстрое реагирование, [утопленные] с плоской розеткой Hızlı tepkili, [gömme] aşağı bakan	P. 1.020
TY-FRB		
	Quick Response, [Recessed] Pendent Быстрое реагирование, [утопленные] с плоской розеткой Hızlı tepkili, [gömme] aşağı bakan	P. 1.021
TY-FRL		
	Quick Response, Conventional Быстрого реагирования, традиционные Hızlı tepkili, konvansiyonel	P. 1.022
TY-FRB		
	Quick Response, [Recessed] Horizontal Sidewall Быстрое реагирование, [утопленные] горизонтальные настенные Hızlı tepkili, [gömme] yatay duvar tipi	P. 1.023
TY-FRB		
	Quick Response, Horizontal Sidewall Быстрое реагирование, горизонтальные настенные Hızlı tepkili, yatay duvar tipi	P. 1.024
TY-FRL		
	Quick Response, Vertical Sidewall Быстрое реагирование, вертикальные настенные Hızlı tepkili, dikey duvar tipi	P. 1.025
TY-FRB		
	Pendent Concealed Скрытые с плоской розеткой Aşağı bakan, gizli	P. 1.026
RFII		

TYCERTFP 03/07 Tyco reserves the right to change the contents without notice

Standard Coverage Sprinklers, Standard Response, Upright

RU Спринклеры со стандартной зоной орошения, стандартное реагирование, с вогнутой розеткой

TR Normal kaplama alanlı sprinklerler, normal tepkili, yukarı bakan



TFP 151

0.08 kg

Art. no. 568504001, W-Type 7
560006387, W-Type 6

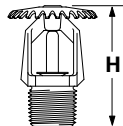

TY-B

K=40 [2.8] • 1/2" NPT • SINTY1151 • H=55.6 mm [2-3/16"]						
Art. No	T °C [°F]	F	FM	UL	CNBOP	BM OKF
575301135	57 [135]	1	√	√	√	√
575301155	68 [155]	1	√	√	√	√
575301175	79 [175]	1	√	√	√	√
575301200	93 [200]	1	√	√	√	√
575301286	141 [286]	1	√	√	√	√
575301360	182 [360]	1	√	√	√	√
575303135	57 [135]	3	√	√	√	√
575303155	68 [155]	3	√	√	√	√
575303175	79 [175]	3	√	√	√	√
575303200	93 [200]	3	√	√	√	√
575303286	141 [286]	3	√	√	√	√
575303360	182 [360]	3	√	√	√	√
575309135	57 [135]	9	√	√	√	√
575309155	68 [155]	9	√	√	√	√
575309175	79 [175]	9	√	√	√	√
575309200	93 [200]	9	√	√	√	√
575309286	141 [286]	9	√	√	√	√
575309360	182 [360]	9	√	√	√	√
575306135	57 [135]	6	√	√		
575306155	68 [155]	6	√	√		
575306175	79 [175]	6	√	√		
575306200	93 [200]	6	√	√		
575306286	141 [286]	6	√	√		

K=80 [5.6] • 1/2" NPT • SINTY3151 • H=55.6 mm [2-3/16"]											
Art. No	T °C [°F]	F	CE	VDS	LPCB	FM	UL	CNBOP	VNIPO	PAVUS	T/S/U BM OKF
575701135	57 [135]	1	√	√	√	√	√	√	√	√	√
575701155	68 [155]	1	√	√	√	√	√	√	√	√	√
575701175	79 [175]	1	√	√	√	√	√	√	√	√	√
575701200	93 [200]	1	√	√	√	√	√	√	√	√	√
575701286	141 [286]	1	√	√	√	√	√	√	√	√	√
575701360	182 [360]	1	√	√	√	√	√	√	√	√	√
575703135	57 [135]	3	√	√	√	√	√	√	√	√	√
575703155	68 [155]	3	√	√	√	√	√	√	√	√	√
575703175	79 [175]	3	√	√	√	√	√	√	√	√	√
575703200	93 [200]	3	√	√	√	√	√	√	√	√	√
575703286	141 [286]	3	√	√	√	√	√	√	√	√	√
575703360	182 [360]	3	√	√	√	√	√	√	√	√	√
575709135	57 [135]	9	√	√	√	√	√	√	√	√	√
575709155	68 [155]	9	√	√	√	√	√	√	√	√	√
575709175	79 [175]	9	√	√	√	√	√	√	√	√	√
575709200	93 [200]	9	√	√	√	√	√	√	√	√	√
575709286	141 [286]	9	√	√	√	√	√	√	√	√	√
575709360	182 [360]	9	√	√	√	√	√	√	√	√	√
575706135	57 [135]	6				√	√				
575706155	68 [155]	6				√	√				
575706175	79 [175]	6				√	√				
575706200	93 [200]	6				√	√				
575706286	141 [286]	6				√	√				

K=115 [8.0] • 1/2" NPT • SINTY4851 • H=55.6 mm [2-3/16"]						
Art. No	T °C [°F]	F	FM	UL	BM OKF	
575601135	57 [135]	1	√	√	√	
575601155	68 [155]	1	√	√	√	
575601175	79 [175]	1	√	√	√	
575601200	93 [200]	1	√	√	√	
575601286	141 [286]	1	√	√	√	
575601360	182 [360]	1	√	√	√	
575603135	57 [135]	3	√	√	√	
575603155	68 [155]	3	√	√	√	
575603175	79 [175]	3	√	√	√	
575603200	93 [200]	3	√	√	√	
575603286	141 [286]	3	√	√	√	
575603360	182 [360]	3	√	√	√	
575609135	57 [135]	9	√	√	√	
575609155	68 [155]	9	√	√	√	
575609175	79 [175]	9	√	√	√	
575609200	93 [200]	9	√	√	√	
575609286	141 [286]	9	√	√	√	
575609360	182 [360]	9	√	√	√	
575606135	57 [135]	6	√	√		
575606155	68 [155]	6	√	√		
575606175	79 [175]	6	√	√		
575606200	93 [200]	6	√	√		
575606286	141 [286]	6	√	√		

K=115 [8.0] • 3/4" NPT • SINTY4151 • H=57.2 mm [2-1/4"]											
Art. No	T °C [°F]	F	CE	VDS	LPCB	FM	UL	CNBOP	VNIPO	PAVUS	T/S/U BM OKF
575901135	57 [135]	1	√	√	√	√	√	√	√	√	√
575901155	68 [155]	1	√	√	√	√	√	√	√	√	√
575901175	79 [175]	1	√	√	√	√	√	√	√	√	√
575901200	93 [200]	1	√	√	√	√	√	√	√	√	√
575901286	141 [286]	1	√	√	√	√	√	√	√	√	√
575901360	182 [360]	1	√	√	√	√	√	√	√	√	√
575903135	57 [135]	3	√	√	√	√	√	√	√	√	√
575903155	68 [155]	3	√	√	√	√	√	√	√	√	√
575903175	79 [175]	3	√	√	√	√	√	√	√	√	√
575903200	93 [200]	3	√	√	√	√	√	√	√	√	√
575903286	141 [286]	3	√	√	√	√	√	√	√	√	√
575903360	182 [360]	3	√	√	√	√	√	√	√	√	√
575909135	57 [135]	9	√	√	√	√	√	√	√	√	√
575909155	68 [155]	9	√	√	√	√	√	√	√	√	√
575909175	79 [175]	9	√	√	√	√	√	√	√	√	√
575909200	93 [200]	9	√	√	√	√	√	√	√	√	√
575909286	141 [286]	9	√	√	√	√	√	√	√	√	√
575909360	182 [360]	9	√	√	√	√	√	√	√	√	√
575906135	57 [135]	6				√	√				
575906155	68 [155]	6				√	√				
575906175	79 [175]	6				√	√				
575906200	93 [200]	6				√	√				
575906286	141 [286]	6				√	√				

TYCERTFP 03/07 Tyco reserves the right to change the contents without notice

Standard Coverage Sprinklers, Standard Response, Upright

RU Спринклеры со стандартной зоной орошения, стандартное реагирование, с вогнутой розеткой

TR Normal kaplama alanlı sprinklerler, normal tepkili, yukarı bakan



 TFP 670

 0.08 kg

 Art. No. 568504001, W-Type 7
560006387, W-Type 6
[P.1.117]

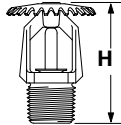

K=57 [4.0] • 3/8" ISO • SINTY2108 • H=53.0 mm [2-1/16"]

Art. No.	T °C [°F]	F	CE	VDS	LPCB	CNBOP	VNIPPO	PAVUS	T/S/U	BM OKF
575801135	57 [135]	1	√	√	√	√	√	√	√	√
575801155	68 [155]	1	√	√	√	√	√	√	√	√
575801175	79 [175]	1	√	√	√	√	√	√	√	√
575801200	93 [200]	1	√	√	√	√	√	√	√	√
575801286	141 [286]	1	√	√	√	√	√	√	√	√
575801360	182 [360]	1	√	√	√	√	√	√	√	√
575803135	57 [135]	3	√	√	√	√	√	√	√	√
575803155	68 [155]	3	√	√	√	√	√	√	√	√
575803175	79 [175]	3	√	√	√	√	√	√	√	√
575803200	93 [200]	3	√	√	√	√	√	√	√	√
575803286	141 [286]	3	√	√	√	√	√	√	√	√
575803360	182 [360]	3	√	√	√	√	√	√	√	√
575809135	57 [135]	9	√	√	√	√	√	√	√	√
575809155	68 [155]	9	√	√	√	√	√	√	√	√
575809175	79 [175]	9	√	√	√	√	√	√	√	√
575809200	93 [200]	9	√	√	√	√	√	√	√	√
575809286	141 [286]	9	√	√	√	√	√	√	√	√
575809360	182 [360]	9	√	√	√	√	√	√	√	√

Standard Coverage Sprinklers, Standard Response, Upright

RU Спринклеры со стандартной зоной орошения, стандартное реагирование, с вогнутой розеткой

TR Normal kaplama alanlı sprinklerler, normal tepkili, yukarı bakan



TFP 110



0.09 kg



[P.1.117]

Art. No. 560001849, W-Type 9
560001948, W-Type 10

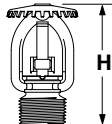

TY-L

K=80 [5.6] • 1/2" NPT • SINTY3111 • H=66.7 mm [2-5/8"]

Art. No.	T °C [°F]	F	CE			
			LPCB	FM	UL	UL
531111165	74 [165]	1	√	√	√	√
531111212	100 [212]	1	√	√	√	√
531111280	138 [280]	1	√	√	√	√
531119165	74 [165]	9	√	√	√	√
531119212	100 [212]	9	√	√	√	√
531119280	138 [280]	9	√	√	√	√
531116165	74 [165]	6			√	√
531116212	100 [212]	6			√	√

K=115 [8.0] • 1/2" NPT • SINTY4811 • H=66.7 mm [2-5/8"]

Art. No.	T °C [°F]	F	FM		UL	
			FM	UL	UL	UL
531061165	74 [165]	1	√	√	√	√
531061212	100 [212]	1	√	√	√	√
531061280	138 [280]	1	√	√	√	√
531069165	74 [165]	9	√	√	√	√
531069212	100 [212]	9	√	√	√	√
531069280	138 [280]	9	√	√	√	√
531066165	74 [165]	6			√	√
531066212	100 [212]	6			√	√

K=115 [8.0] • 3/4" NPT • SINTY4111 • H=68.3 mm [2-11/16"]

Art. No.	T °C [°F]	F	CE			
			LPCB	FM	UL	UL
531011165	74 [165]	1	√	√	√	√
531011212	100 [212]	1	√	√	√	√
531011280	138 [280]	1	√	√	√	√
531019165	74 [165]	9	√	√	√	√
531019212	100 [212]	9	√	√	√	√
531019280	138 [280]	9	√	√	√	√
531016165	74 [165]	6			√	√
531016212	100 [212]	6			√	√

Standard Coverage Sprinklers, Standard Response, [Recessed] Pendent

RU Спринклеры со стандартной зоной орошения, стандартное реагирование, [утопленные]с плоской розеткой

TR Normal kaplama alanlı sprinklerler, normal tepkili, [gömme] asagi bakan



TY-B



TFP 151



0.08 kg



Art. No. 568504001, W-Type 7
560006387, W-Type 6

[P.1.117]



Style 10, 20, 30 & 40

[P.1.105]

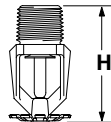

K=40 [2.8] • 1/2" NPT • SIN TY1251 • H=57.2 mm [2-1/4"]						
Art. No.	T °C [°F]	F	FM	UL	CNBOP	BM OKF
575311135	57 [135]	1	√	√	√	√
575311155	68 [155]	1	√	√	√	√
575311175	79 [175]	1	√	√	√	√
575311200	93 [200]	1	√	√	√	√
575311286	141 [286]	1	√	√	√	√
575311360	182 [360]	1	√	√	√	√
575313135	57 [135]	3	√	√	√	√
575313155	68 [155]	3	√	√	√	√
575313175	79 [175]	3	√	√	√	√
575313200	93 [200]	3	√	√	√	√
575313286	141 [286]	3	√	√	√	√
575313360	182 [360]	3	√	√	√	√
575319135	57 [135]	9	√	√	√	√
575319155	68 [155]	9	√	√	√	√
575319175	79 [175]	9	√	√	√	√
575319200	93 [200]	9	√	√	√	√
575319286	141 [286]	9	√	√	√	√
575319360	182 [360]	9	√	√	√	√
575316135	57 [135]	6	√	√		
575316155	68 [155]	6	√	√		
575316175	79 [175]	6	√	√		
575316200	93 [200]	6	√	√		
575316286	141 [286]	6	√	√		

K=80 [5.6] • 1/2" NPT • SIN TY3251 • H=55.6 mm [2-3/16"]												
Art. No.	T °C [°F]	F	CE	VDS	LPCB	FM	UL	CNBOP	VNIPO	PAVUS	T/S/U	BM OKF
575711135	57 [135]	1	√	√	√	√	√	√	√	√	√	√
575711155	68 [155]	1	√	√	√	√	√	√	√	√	√	√
575711175	79 [175]	1	√	√	√	√	√	√	√	√	√	√
575711200	93 [200]	1	√	√	√	√	√	√	√	√	√	√
575711286	141 [286]	1	√	√	√	√	√	√	√	√	√	√
575711360	182 [360]	1	√	√	√	√	√	√	√	√	√	√
575713135	57 [135]	3	√	√	√	√	√	√	√	√	√	√
575713155	68 [155]	3	√	√	√	√	√	√	√	√	√	√
575713175	79 [175]	3	√	√	√	√	√	√	√	√	√	√
575713200	93 [200]	3	√	√	√	√	√	√	√	√	√	√
575713286	141 [286]	3	√	√	√	√	√	√	√	√	√	√
575713360	182 [360]	3	√	√	√	√	√	√	√	√	√	√
575719135	57 [135]	9	√	√	√	√	√	√	√	√	√	√
575719155	68 [155]	9	√	√	√	√	√	√	√	√	√	√
575719175	79 [175]	9	√	√	√	√	√	√	√	√	√	√
575719200	93 [200]	9	√	√	√	√	√	√	√	√	√	√
575719286	141 [286]	9	√	√	√	√	√	√	√	√	√	√
575719360	182 [360]	9	√	√	√	√	√	√	√	√	√	√
575716135	57 [135]	6				√	√					
575716155	68 [155]	6				√	√					
575716175	79 [175]	6				√	√					
575716200	93 [200]	6				√	√					
575716286	141 [286]	6				√	√					

K=115 [8.0] • 1/2" NPT • SIN TY4951 • H=57.2 mm [2-1/4"]						
Art. No.	T °C [°F]	F	FM	UL	CNBOP	BM OKF
575611135	57 [135]	1	√	√	√	√
575611155	68 [155]	1	√	√	√	√
575611175	79 [175]	1	√	√	√	√
575611200	93 [200]	1	√	√	√	√
575611286	141 [286]	1	√	√	√	√
575611360	182 [360]	1	√	√	√	√
575613135	57 [135]	3	√	√	√	√
575613155	68 [155]	3	√	√	√	√
575613175	79 [175]	3	√	√	√	√
575613200	93 [200]	3	√	√	√	√
575613286	141 [286]	3	√	√	√	√
575613360	182 [360]	3	√	√	√	√
575619135	57 [135]	9	√	√	√	√
575619155	68 [155]	9	√	√	√	√
575619175	79 [175]	9	√	√	√	√
575619200	93 [200]	9	√	√	√	√
575619286	141 [286]	9	√	√	√	√
575619360	182 [360]	9	√	√	√	√
575616135	57 [135]	6	√	√		
575616155	68 [155]	6	√	√		
575616175	79 [175]	6	√	√		
575616200	93 [200]	6	√	√		
575616286	141 [286]	6	√	√		

K=115 [8.0] • 3/4" NPT • SIN TY4251 • H=58.7 mm [2-5/16"]											
Art. No.	T °C [°F]	F	CE	VDS	FM	UL	CNBOP	VNIPO	PAVUS	T/S/U	BM OKF
575911135	57 [135]	1	√	√	√	√	√	√	√	√	√
575911155	68 [155]	1	√	√	√	√	√	√	√	√	√
575911175	79 [175]	1	√	√	√	√	√	√	√	√	√
575911200	93 [200]	1	√	√	√	√	√	√	√	√	√
575911286	141 [286]	1	√	√	√	√	√	√	√	√	√
575911360	182 [360]	1	√	√	√	√	√	√	√	√	√
575913135	57 [135]	3	√	√	√	√	√	√	√	√	√
575913155	68 [155]	3	√	√	√	√	√	√	√	√	√
575913175	79 [175]	3	√	√	√	√	√	√	√	√	√
575913200	93 [200]	3	√	√	√	√	√	√	√	√	√
575913286	141 [286]	3	√	√	√	√	√	√	√	√	√
575913360	182 [360]	3	√	√	√	√	√	√	√	√	√
575919135	57 [135]	9	√	√	√	√	√	√	√	√	√
575919155	68 [155]	9	√	√	√	√	√	√	√	√	√
575919175	79 [175]	9	√	√	√	√	√	√	√	√	√
575919200	93 [200]	9	√	√	√	√	√	√	√	√	√
575919286	141 [286]	9	√	√	√	√	√	√	√	√	√
575919360	182 [360]	9	√	√	√	√	√	√	√	√	√
575916135	57 [135]	6	√	√	√	√					
575916155	68 [155]	6	√	√	√	√					
575916175	79 [175]	6	√	√	√	√					
575916200	93 [200]	6	√	√	√	√					
575916286	141 [286]	6	√	√	√	√					

TYCERTFP 03/07 Tyco reserves the right to change the contents without notice

Standard Coverage Sprinklers, Standard Response, Pendent

RU Спринклеры со стандартной зоной орошения, стандартное реагирование, с плоской розеткой

TR Normal kaplama alanlı sprinklerler, normal tepkili, asagi bakan



TFP 670



0.08 kg



[P.1.117]

Art. No. 568504001, W-Type 7
560006387, W-Type 6

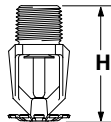

K=57 [4.0] • 3/8" ISO • SIN TY2208 • H=55 mm [2-1/6"]

Art. No.	T °C [°F]	F	CE	VDS	LPCB	CNBOP	PAVUS	T/SU	BM OKF
575811135	57 [135]	1	√	√	√	√	√	√	√
575811155	68 [155]	1	√	√	√	√	√	√	√
575811175	79 [175]	1	√	√	√	√	√	√	√
575811200	93 [200]	1	√	√	√	√	√	√	√
575811286	141 [286]	1	√	√	√	√	√	√	√
575811360	182 [360]	1	√	√	√	√	√	√	√
575813135	57 [135]	3	√	√	√	√	√	√	√
575813155	68 [155]	3	√	√	√	√	√	√	√
575813175	79 [175]	3	√	√	√	√	√	√	√
575813200	93 [200]	3	√	√	√	√	√	√	√
575813286	141 [286]	3	√	√	√	√	√	√	√
575813360	182 [360]	3	√	√	√	√	√	√	√
575819135	57 [135]	9	√	√	√	√	√	√	√
575819155	68 [155]	9	√	√	√	√	√	√	√
575819175	79 [175]	9	√	√	√	√	√	√	√
575819200	93 [200]	9	√	√	√	√	√	√	√
575819286	141 [286]	9	√	√	√	√	√	√	√
575819360	182 [360]	9	√	√	√	√	√	√	√

Standard Coverage Sprinklers, Standard Response, [Recessed] Pendent

RU Спринклеры со стандартной зоной орошения, стандартное реагирование, [утопленные]с плоской розеткой

TR Normal kaplama alanlı sprinklerler, normal tepkili, asagi bakan



TFP 110



0.09 kg



Art. No. 560001849, W-Type 9
560001948, W-Type 10



Style 10-40

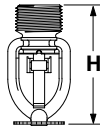

K=80 [5.6] • 1/2" NPT • SINTY3211 • H=66.7 mm [2-5/8"]						
Art. No.	T °C [°F]	F	CE	LP	FM	UL
531121165	74 [165]	1	√	√	√	√
531121212	100 [212]	1	√	√	√	√
531121280	138 [280]	1	√	√	√	√
531129165	74 [165]	9	√	√	√	√
531129212	100 [212]	9	√	√	√	√
531129280	138 [280]	9	√	√	√	√
531126165	74 [165]	6			√	√
531126212	100 [212]	6			√	√

K=115 [8.0] • 1/2" NPT • SINTY4911 • H=66.7 mm [2-5/8"]					
Art. No.	T °C [°F]	F	FM	UL	
531071165	74 [165]	1	√	√	
531071212	100 [212]	1	√	√	
531071280	138 [280]	1	√	√	
531079165	74 [165]	9	√	√	
531079212	100 [212]	9	√	√	
531079280	138 [280]	9	√	√	
531076165	74 [165]	6	√	√	
531076212	100 [212]	6	√	√	

K=115 [8.0] • 3/4" NPT • SINTY4211 • H=68.3 mm [2-11/16"]						
Art. No.	T °C [°F]	F	CE	LP	FM	UL
531021165	74 [165]	1	√	√	√	√
531021212	100 [212]	1	√	√	√	√
531021280	138 [280]	1	√	√	√	√
531029165	74 [165]	9	√	√	√	√
531029212	100 [212]	9	√	√	√	√
531026165	74 [165]	6			√	√
531026212	100 [212]	6			√	√

TYCERTFP 03/07 Tyco reserves the right to change the contents without notice

Standard Coverage Sprinklers, Standard Response, Conventional

RU Спринклеры со стандартной зоной орошения, стандартное реагирование, традиционные

TR Normal kaplama alanlı sprinklerler, normal tepkili, Konvansiyonel



 **TFP 661**

 **0.08 kg**

 **Art. No. 568504001, W-Type 7**
560006387, W-Type 6

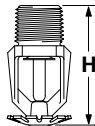

K=80 [5.6] • 1/2" NPT • SINTY3651 • H=55.6 mm [2-3/16"]										
Art. No.	T °C [°F]	F	CE	VDS	LPCB	UL	VNIPO	PAVUS	T/SU	BM OKF
575731135	57 [135]	1	√	√	√	√	√	√	√	√
575731155	68 [155]	1	√	√	√	√	√	√	√	√
575731175	79 [175]	1	√	√	√	√	√	√	√	√
575731200	93 [200]	1	√	√	√	√	√	√	√	√
575731286	141 [286]	1	√	√	√	√	√	√	√	√
575731360	182 [360]	1	√	√	√	√	√	√	√	√
575733135	57 [135]	3	√	√	√	√	√	√	√	√
575733155	68 [155]	3	√	√	√	√	√	√	√	√
575733175	79 [175]	3	√	√	√	√	√	√	√	√
575733200	93 [200]	3	√	√	√	√	√	√	√	√
575733286	141 [286]	3	√	√	√	√	√	√	√	√
575733360	182 [360]	3	√	√	√	√	√	√	√	√
575739135	57 [135]	9	√	√	√	√	√	√	√	√
575739155	68 [155]	9	√	√	√	√	√	√	√	√
575739175	79 [175]	9	√	√	√	√	√	√	√	√
575739200	93 [200]	9	√	√	√	√	√	√	√	√
575739286	141 [286]	9	√	√	√	√	√	√	√	√
575739360	182 [360]	9	√	√	√	√	√	√	√	√
575736135	57 [135]	6				√				
575736155	68 [155]	6				√				
575736175	79 [175]	6				√				
575736200	93 [200]	6				√				
575736286	141 [286]	6				√				

K=115 [8.0] • 3/4" NPT • SINTY4651 • H=57.2 mm [2-3/16"]										
Art. No.	T °C [°F]	F	CE	VDS	LPCB	UL	VNIPO	PAVUS	T/SU	BM OKF
575931135	57 [135]	1	√	√	√	√	√	√	√	√
575931155	68 [155]	1	√	√	√	√	√	√	√	√
575931175	79 [175]	1	√	√	√	√	√	√	√	√
575931200	93 [200]	1	√	√	√	√	√	√	√	√
575931286	141 [286]	1	√	√	√	√	√	√	√	√
575931360	182 [360]	1	√	√	√	√	√	√	√	√
575933135	57 [135]	3	√	√	√	√	√	√	√	√
575933155	68 [155]	3	√	√	√	√	√	√	√	√
575933175	79 [175]	3	√	√	√	√	√	√	√	√
575933200	93 [200]	3	√	√	√	√	√	√	√	√
575933286	141 [286]	3	√	√	√	√	√	√	√	√
575933360	182 [360]	3	√	√	√	√	√	√	√	√
575939135	57 [135]	9	√	√	√	√	√	√	√	√
575939155	68 [155]	9	√	√	√	√	√	√	√	√
575939175	79 [175]	9	√	√	√	√	√	√	√	√
575939200	93 [200]	9	√	√	√	√	√	√	√	√
575939286	141 [286]	9	√	√	√	√	√	√	√	√
575939360	182 [360]	9	√	√	√	√	√	√	√	√
575936135	57 [135]	6				√				
575936155	68 [155]	6				√				
575936175	79 [175]	6				√				
575936200	93 [200]	6				√				
575936286	141 [286]	6				√				

TYCER TFP 03/07 Tyco reserves the right to change the contents without notice

RU Спринклеры со стандартной зоной орошения, стандартное реагирование, [утопленные] горизонтальные настенные

TR Normal kaplama alanlı sprinklerler, normal tepkili, [gömme] yatay duvar tipi



TFP 161



0.08 kg



**Art. No. 568504001, W-Type 7
560006387, W-Type 6**

[P.1.117]



Style 10, 20, 30 & 40

[P.1.107]

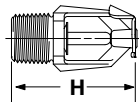

Art. No.	T °C [°F]	F	CE	LPCB	FM	UL	CNBOP	VNIPO	PAVUS	BM OKF	K=80 [5.6] • 1/2" NPT • SINTY3351 • H=55.6 mm [2-3/16"]	
											CE	UL
575781135	57 [135]	1	√	√	√	√	√	√	√	√	√	√
575781155	68 [155]	1	√	√	√	√	√	√	√	√	√	√
575781175	79 [175]	1	√	√	√	√	√	√	√	√	√	√
575781200	93 [200]	1	√	√	√	√	√	√	√	√	√	√
575781286	141 [286]	1	√	√	√	√	√	√	√	√	√	√
575781360	182 [360]	1	√	√	√	√	√	√	√	√	√	√
575783135	57 [135]	3	√	√	√	√	√	√	√	√	√	√
575783155	68 [155]	3	√	√	√	√	√	√	√	√	√	√
575783175	79 [175]	3	√	√	√	√	√	√	√	√	√	√
575783200	93 [200]	3	√	√	√	√	√	√	√	√	√	√
575783286	141 [286]	3	√	√	√	√	√	√	√	√	√	√
575783360	182 [360]	3	√	√	√	√	√	√	√	√	√	√
575789135	57 [135]	9	√	√	√	√	√	√	√	√	√	√
575789155	68 [155]	9	√	√	√	√	√	√	√	√	√	√
575789175	79 [175]	9	√	√	√	√	√	√	√	√	√	√
575789200	93 [200]	9	√	√	√	√	√	√	√	√	√	√
575789286	141 [286]	9	√	√	√	√	√	√	√	√	√	√
575789360	182 [360]	9	√	√	√	√	√	√	√	√	√	√
575786135	57 [135]	6			√	√						
575786155	68 [155]	6			√	√						
575786175	79 [175]	6			√	√						
575786200	93 [200]	6			√	√						
575786286	141 [286]	6			√	√						

Standard Coverage Sprinklers, Standard Response, Horizontal Sidewall

- RU** Спринклеры со стандартной зоной орошения, стандартное реагирование, горизонтальные настенные
- TR** Normal kaplama alanlı sprinklerler, normal tepkili, yatay duvar tipi



TFP 120



0.09 kg



[P.1.117]

Art. No. 560001849, W-Type 9

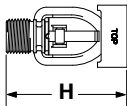

K=80 [5.6] • 1/2" NPT • SINTY3311 • H=55.6 mm [2-3/16"]

Art. No.	T °C [°F]	F	CE	LPCB	FM	UL
531131165	74 [165]	1	√	√	√	√
531131212	100 [212]	1	√	√	√	√
531131280	138 [280]	1	√	√	√	√
531139165	74 [165]	9	√	√	√	√
531139212	100 [212]	9	√	√	√	√
531139280	138 [280]	9	√	√	√	√
531136165	74 [165]	6			√	√
531136212	100 [212]	6			√	√

Standard Coverage Sprinklers, Standard Response, Vertical Sidewall

RU Спринклеры со стандартной зоной орошения, стандартное реагирование, вертикальные настенные

TR Normal kaplama alanlı sprinklerler, normal tepkili, dikey duvar tipi



 **TFP 161**

 **0.08 kg**

 **Art. No. 568504001, W-Type 7**
560006387, W-Type 6

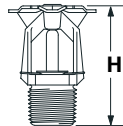

K=80 [5.6] • 1/2" NPT • SINTY3451 • H=63.5 mm [2-1/2"]

Art. No.	T °C [°F]	F	CE	LPCB	FM	UL	PAVUS
575751135	57 [135]	1	√	√	√	√	√
575751155	68 [155]	1	√	√	√	√	√
575751175	79 [175]	1	√	√	√	√	√
575751200	93 [200]	1	√	√	√	√	√
575751286	141 [286]	1	√	√	√	√	√
575751360	182 [360]	1	√	√	√	√	√
575753135	57 [135]	3	√	√	√	√	√
575753155	68 [155]	3	√	√	√	√	√
575753175	79 [175]	3	√	√	√	√	√
575753200	93 [200]	3	√	√	√	√	√
575753286	141 [286]	3	√	√	√	√	√
575753360	182 [360]	3	√	√	√	√	√
575759135	57 [135]	9	√	√	√	√	√
575759155	68 [155]	9	√	√	√	√	√
575759175	79 [175]	9	√	√	√	√	√
575759200	93 [200]	9	√	√	√	√	√
575759286	141 [286]	9	√	√	√	√	√
575759360	182 [360]	9	√	√	√	√	√
575756135	57 [135]	6			√	√	
575756155	68 [155]	6			√	√	
575756175	79 [175]	6			√	√	
575756200	93 [200]	6			√	√	
575756286	141 [286]	6			√	√	

Standard Coverage Sprinklers, Special Response, Upright

RU Спринклеры со стандартной зоной орошения, особое реагирование, с вогнутой розеткой

TR Normal kaplama alanlı sprinklerler, özel tepkili, yukarı bakan



TY-B

 TFP 672

 0.08 kg

 Art. No. 568504001, W-Type 7
560006387, W-Type 6

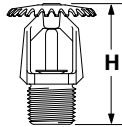

K=57 [4.0] • 3/8" NPT • SINTY2149 • H=55.6 mm [2-3/16"]				
Art. No.	T °C [°F]	F	CE	VDS
574801135	57 [135]	1	√	√
574801155	68 [155]	1	√	√
574801175	79 [175]	1	√	√
574801200	93 [200]	1	√	√
574801286	141 [286]	1	√	√
574801360	182 [360]	1	√	√
574803135	57 [135]	3	√	√
574803155	68 [155]	3	√	√
574803175	79 [175]	3	√	√
574803200	93 [200]	3	√	√
574803286	141 [286]	3	√	√
574803360	182 [360]	3	√	√
574809135	57 [135]	9	√	√
574809155	68 [155]	9	√	√
574809175	79 [175]	9	√	√
574809200	93 [200]	9	√	√
574809286	141 [286]	9	√	√
574809360	182 [360]	9	√	√

K=80 [5.6] • 1/2" NPT • SINTY3141 • H=55.6 mm [2-3/16"]				
Art. No.	T °C [°F]	F	CE	VDS
574701135	57 [135]	1	√	√
574701155	68 [155]	1	√	√
574701175	79 [175]	1	√	√
574701200	93 [200]	1	√	√
574701286	141 [286]	1	√	√
574701360	182 [360]	1	√	√
574703135	57 [135]	3	√	√
574703155	68 [155]	3	√	√
574703175	79 [175]	3	√	√
574703200	93 [200]	3	√	√
574703286	141 [286]	3	√	√
574703360	182 [360]	3	√	√
574709135	57 [135]	9	√	√
574709155	68 [155]	9	√	√
574709175	79 [175]	9	√	√
574709200	93 [200]	9	√	√
574709286	141 [286]	9	√	√
574709360	182 [360]	9	√	√

K=115 [8.0] • 3/4" NPT • SINTY4141 • H=55.6 mm [2-3/16"]				
Art. No.	T °C [°F]	F	CE	VDS
574901135	57 [135]	1	√	√
574901155	68 [155]	1	√	√
574901175	79 [175]	1	√	√
574901200	93 [200]	1	√	√
574901286	141 [286]	1	√	√
574901360	182 [360]	1	√	√
574903135	57 [135]	3	√	√
574903155	68 [155]	3	√	√
574903175	79 [175]	3	√	√
574903200	93 [200]	3	√	√
574903286	141 [286]	3	√	√
574903360	182 [360]	3	√	√
574909135	57 [135]	9	√	√
574909155	68 [155]	9	√	√
574909175	79 [175]	9	√	√
574909200	93 [200]	9	√	√
574909286	141 [286]	9	√	√
574909360	182 [360]	9	√	√

TYCER TFP 03/07 Tyco reserves the right to change the contents without notice

Standard Coverage Sprinklers, Special Response, [Recessed] Pendent

RU Спринклеры со стандартной зоной орошения, особое реагирование, [утопленные] с плоской розеткой

TR Normal kaplama alanlı sprinklerler, özel tepkili, [gömme] asagi bakan



 **TFP 672**

 **0.08 kg**

 **Art. No. 568504001, W-Type 7**
560006387, W-Type 6

[P.1.117]

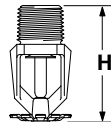

K=57 [4.0] • 3/8" BSP • SINTY2249 • H=55.6 mm [2-3/16"]				
Art. No.	T °C [°F]	F	CE	VDS
574811135	57 [135]	1	√	√
574811155	68 [155]	1	√	√
574811175	79 [175]	1	√	√
574811200	93 [200]	1	√	√
574811286	141 [286]	1	√	√
574811360	182 [360]	1	√	√
574813135	57 [135]	3	√	√
574813155	68 [155]	3	√	√
574813175	79 [175]	3	√	√
574813200	93 [200]	3	√	√
574813286	141 [286]	3	√	√
574813360	182 [360]	3	√	√
574819135	57 [135]	9	√	√
574819155	68 [155]	9	√	√
574819175	79 [175]	9	√	√
574819200	93 [200]	9	√	√
574819286	141 [286]	9	√	√
574819360	182 [360]	9	√	√

K=80 [5.6] • 1/2" NPT • SINTY3241 • H=55.6 mm [2-3/16"]				
Art. No.	T °C [°F]	F	CE	VDS
574711135	57 [135]	1	√	√
574711155	68 [155]	1	√	√
574711175	79 [175]	1	√	√
574711200	93 [200]	1	√	√
574711286	141 [286]	1	√	√
574711360	182 [360]	1	√	√
574713135	57 [135]	3	√	√
574713155	68 [155]	3	√	√
574713175	79 [175]	3	√	√
574713200	93 [200]	3	√	√
574713286	141 [286]	3	√	√
574713360	182 [360]	3	√	√
574719135	57 [135]	9	√	√
574719155	68 [155]	9	√	√
574719175	79 [175]	9	√	√
574719200	93 [200]	9	√	√
574719286	141 [286]	9	√	√
574719360	182 [360]	9	√	√

K=115 [8.0] • 3/4" NPT • SINTY4241 • H=55.6 mm [2-3/16"]				
Art. No.	T °C [°F]	F	CE	VDS
574911135	57 [135]	1	√	√
574911155	68 [155]	1	√	√
574911175	79 [175]	1	√	√
574911200	93 [200]	1	√	√
574911286	141 [286]	1	√	√
574911360	182 [360]	1	√	√
574913135	57 [135]	3	√	√
574913155	68 [155]	3	√	√
574913175	79 [175]	3	√	√
574913200	93 [200]	3	√	√
574913286	141 [286]	3	√	√
574913360	182 [360]	3	√	√
574919135	57 [135]	9	√	√
574919155	68 [155]	9	√	√
574919175	79 [175]	9	√	√
574919200	93 [200]	9	√	√
574919286	141 [286]	9	√	√
574919360	182 [360]	9	√	√

TYCER TFP 03/07 Tyco reserves the right to change the contents without notice

RU Спринклеры со стандартной зоной орошения, особое реагирование, традиционные

TR Normal kaplama alanlı sprinklerler, özel tepkili, konvensiyonel



 **TFP 663**

 **0.08 kg**

 **Art. No. 568504001, W-Type 7**
560006387, W-Type 6
[P.1.117]

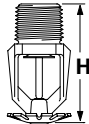

K=80 [5.6] • 1/2" NPT • SINTY3641 • H=55.6 mm [2-3/16"]				
Art. No.	T °C [°F]	F	CE	VDS
574731135	57 [135]	1	√	√
574731155	68 [155]	1	√	√
574731175	79 [175]	1	√	√
574731200	93 [200]	1	√	√
574731286	141 [286]	1	√	√
574731360	182 [360]	1	√	√
574733135	57 [135]	3	√	√
574733155	68 [155]	3	√	√
574733175	79 [175]	3	√	√
574733200	93 [200]	3	√	√
574733286	141 [286]	3	√	√
574733360	182 [360]	3	√	√
574739135	57 [135]	9	√	√
574739155	68 [155]	9	√	√
574739175	79 [175]	9	√	√
574739200	93 [200]	9	√	√
574739286	141 [286]	9	√	√
574739360	182 [360]	9	√	√

K=115 [8.0] • 3/4" NPT • SINTY4641 • H=55.6 mm [2-3/16"]				
Art. No.	T °C [°F]	F	CE	VDS
574931135	57 [135]	1	√	√
574931155	68 [155]	1	√	√
574931175	79 [175]	1	√	√
574931200	93 [200]	1	√	√
574931286	141 [286]	1	√	√
574931360	182 [360]	1	√	√
574933135	57 [135]	3	√	√
574933155	68 [155]	3	√	√
574933175	79 [175]	3	√	√
574933200	93 [200]	3	√	√
574933286	141 [286]	3	√	√
574933360	182 [360]	3	√	√
574939135	57 [135]	9	√	√
574939155	68 [155]	9	√	√
574939175	79 [175]	9	√	√
574939200	93 [200]	9	√	√
574939286	141 [286]	9	√	√
574939360	182 [360]	9	√	√

Standard Coverage Sprinklers, Quick Response, Upright

RU Спринклеры со стандартной зоной орошения, быстрое реагирование, с вогнутой розеткой

TR Normal kaplama alanlı sprinklerler, hızlı tepkili, yukarı bakan



TFP 171 / 670 [K=57]



0.08 kg



Art. No. 568504001, W-Type 7
560006387, W-Type 6

[P.1.117]

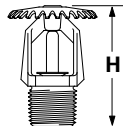

TY-FRB

K=40 [2.8] • 1/2" NPT • SINTY1131 • H=55.6 mm [2-3/16"]

Art. No.	T °C [°F]	F	FM	UL	CNBOP	BM OKF
573301135	57 [135]	1	√	√	√	√
573301155	68 [155]	1	√	√	√	√
573301175	79 [175]	1	√	√	√	√
573301200	93 [200]	1	√	√	√	√
573301286	141 [286]	1	√	√	√	√
573303135	57 [135]	3	√	√	√	√
573303155	68 [155]	3	√	√	√	√
573303175	79 [175]	3	√	√	√	√
573303200	93 [200]	3	√	√	√	√
573303286	141 [286]	3	√	√	√	√
573309135	57 [135]	9	√	√	√	√
573309155	68 [155]	9	√	√	√	√
573309175	79 [175]	9	√	√	√	√
573309200	93 [200]	9	√	√	√	√
573309286	141 [286]	9	√	√	√	√

K=80 [5.6] • 1/2" NPT • SINTY3131 • H=55.6 mm [2-3/16"]

Art. No.	T °C [°F]	F	CE	VDS	LPCB	FM	UL	CNBOP	VNIPO	PAVUS	T/S/U	BM OKF
573701135	57 [135]	1	√	√	√	√	√	√	√	√	√	√
573701155	68 [155]	1	√	√	√	√	√	√	√	√	√	√
573701175	79 [175]	1	√	√	√	√	√	√	√	√	√	√
573701200	93 [200]	1	√	√	√	√	√	√	√	√	√	√
573701286	141 [286]	1	√	√	√	√	√	√	√	√	√	√
573703135	57 [135]	3	√	√	√	√	√	√	√	√	√	√
573703155	68 [155]	3	√	√	√	√	√	√	√	√	√	√
573703175	79 [175]	3	√	√	√	√	√	√	√	√	√	√
573703200	93 [200]	3	√	√	√	√	√	√	√	√	√	√
573703286	141 [286]	3	√	√	√	√	√	√	√	√	√	√
573709135	57 [135]	9	√	√	√	√	√	√	√	√	√	√
573709155	68 [155]	9	√	√	√	√	√	√	√	√	√	√
573709175	79 [175]	9	√	√	√	√	√	√	√	√	√	√
573709200	93 [200]	9	√	√	√	√	√	√	√	√	√	√
573709286	141 [286]	9	√	√	√	√	√	√	√	√	√	√

K=115 [8.0] • 3/4" NPT • SINTY4131 • H=57.2 mm [2-1/4"]

Art. No.	T °C [°F]	F	CE	VDS	LPCB	FM	UL	CNBOP	VNIPO	PAVUS	T/S/U	BM OKF
573901135	57 [135]	1	√	√	√	√	√	√	√	√	√	√
573901155	68 [155]	1	√	√	√	√	√	√	√	√	√	√
573901175	79 [175]	1	√	√	√	√	√	√	√	√	√	√
573901200	93 [200]	1	√	√	√	√	√	√	√	√	√	√
573901286	141 [286]	1	√	√	√	√	√	√	√	√	√	√
573903135	57 [135]	3	√	√	√	√	√	√	√	√	√	√
573903155	68 [155]	3	√	√	√	√	√	√	√	√	√	√
573903175	79 [175]	3	√	√	√	√	√	√	√	√	√	√
573903200	93 [200]	3	√	√	√	√	√	√	√	√	√	√
573903286	141 [286]	3	√	√	√	√	√	√	√	√	√	√
573909135	57 [135]	9	√	√	√	√	√	√	√	√	√	√
573909155	68 [155]	9	√	√	√	√	√	√	√	√	√	√
573909175	79 [175]	9	√	√	√	√	√	√	√	√	√	√
573909200	93 [200]	9	√	√	√	√	√	√	√	√	√	√
573909286	141 [286]	9	√	√	√	√	√	√	√	√	√	√

K=57 [4.0] • 3/8" ISO • SINTY2109 • H=53.0 mm [2-1/11"]

Art. No.	T °C [°F]	F	CE	VDS	LPCB	FM	UL	CNBOP	VNIPO	PAVUS	T/S/U	BM OKF
573801135	57 [135]	1	√	√	√	√	√	√	√	√	√	√
573801155	68 [155]	1	√	√	√	√	√	√	√	√	√	√
573801175	79 [175]	1	√	√	√	√	√	√	√	√	√	√
573801200	93 [200]	1	√	√	√	√	√	√	√	√	√	√
573801286	141 [286]	1	√	√	√	√	√	√	√	√	√	√
573803135	57 [135]	3	√	√	√	√	√	√	√	√	√	√
573803155	68 [155]	3	√	√	√	√	√	√	√	√	√	√
573803175	79 [175]	3	√	√	√	√	√	√	√	√	√	√
573803200	93 [200]	3	√	√	√	√	√	√	√	√	√	√
573803286	141 [286]	3	√	√	√	√	√	√	√	√	√	√
573809135	57 [135]	9	√	√	√	√	√	√	√	√	√	√
573809155	68 [155]	9	√	√	√	√	√	√	√	√	√	√
573809175	79 [175]	9	√	√	√	√	√	√	√	√	√	√
573809200	93 [200]	9	√	√	√	√	√	√	√	√	√	√
573809286	141 [286]	9	√	√	√	√	√	√	√	√	√	√

TYCER TFP 03/07 Tyco reserves the right to change the contents without notice

Standard Coverage Sprinklers, Quick Response, Upright

RU Спринклеры со стандартной зоной орошения, быстрое реагирование, с вогнутой розеткой

TR Normal kaplama alanlı sprinklerler, hızlı tepkili, yukarı bakan



TFP 130



0.09 kg



Art. No. 560001849, W-Type 9
560001948, W-Type 10

[P.1.117]

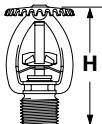

K=40 [2.8] • 1/2" NPT • SINTY1121 • H=68.3 mm [2-11/16"]

Art. No.	T	F	FM	UL
	°C [°F]			
589731165	74 [165]	1	√	√
589731212	100 [212]	1	√	√
589739165	74 [165]	9	√	√
589739212	100 [212]	9	√	√

K=80 [5.6] • 1/2" NPT • SINTY3121 • H=68.3 mm [2-11/16"]

Art. No.	T	F	CE	LPCB	FM	UL
	°C [°F]					
589741165	74 [165]	1	√	√	√	√
589741212	100 [212]	1	√	√	√	√
589749165	74 [165]	9	√	√	√	√
589749212	100 [212]	9	√	√	√	√

K=115 [8.0] • 3/4" NPT • SINTY4121 • H=71.4 mm [2-13/16"]

Art. No.	T	F	CE	FM	UL
	°C [°F]				
581741165	74 [165]	1	√	√	√
581741212	100 [212]	1	√	√	√
581749165	74 [165]	9	√	√	√
581749212	100 [212]	9	√	√	√

Standard Coverage Sprinklers, Quick Response, [Recessed] Pendent

RU Спринклеры со стандартной зоной орошения, быстрое реагирование, [утопленные] с плоской розеткой

TR Normal kaplama alanlı sprinklerler, hızlı tepkili, [gömme] asagi bakan

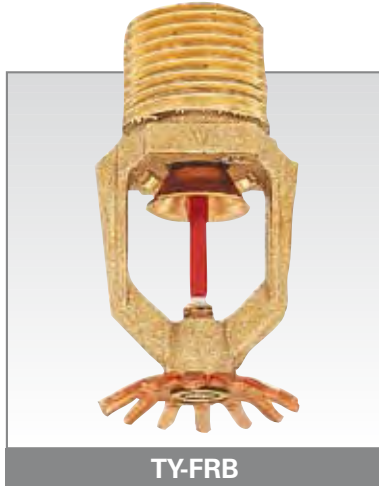

 TFP 171 / 670 [K=57]

 0.08 kg

 Art. No. 568504001, W-Type 7
560006387, W-Type 6

[P.1.117]

 Style 10, 20, 30 & 40

[P.1.107]

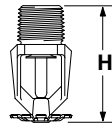

K=40 [2.8] • 1/2" NPT • SIN TY1231 • H=57.2 mm [2-1/4"]							
Art. No.	T °C [°F]	F	CE	FM	UL	CNBOP	BM OKF
573311135	57 [135]	1	✓	✓	✓	✓	✓
573311155	68 [155]	1	✓	✓	✓	✓	✓
573311175	79 [175]	1	✓	✓	✓	✓	✓
573311200	93 [200]	1	✓	✓	✓	✓	✓
573311286	141 [286]	1	✓	✓	✓	✓	✓
573313135	57 [135]	3	✓	✓	✓	✓	✓
573313155	68 [155]	3	✓	✓	✓	✓	✓
573313175	79 [175]	3	✓	✓	✓	✓	✓
573313200	93 [200]	3	✓	✓	✓	✓	✓
573313286	141 [286]	3	✓	✓	✓	✓	✓
573319135	57 [135]	9	✓	✓	✓	✓	✓
573319155	68 [155]	9	✓	✓	✓	✓	✓
573319175	79 [175]	9	✓	✓	✓	✓	✓
573319200	93 [200]	9	✓	✓	✓	✓	✓
573319286	141 [286]	9	✓	✓	✓	✓	✓

K=80 [5.6] • 1/2" NPT • SIN TY3231 • H=55.6 mm [2-3/16"]												
Art. No.	T °C [°F]	F	CE	VDS	LPCB	FM	UL	CNBOP	VNIPO	PAVUS	T/S/U	BM OKF
573711135	57 [135]	1	✓	✓	✓	✓	✓	✓	✓	✓	✓	✓
573711155	68 [155]	1	✓	✓	✓	✓	✓	✓	✓	✓	✓	✓
573711175	79 [175]	1	✓	✓	✓	✓	✓	✓	✓	✓	✓	✓
573711200	93 [200]	1	✓	✓	✓	✓	✓	✓	✓	✓	✓	✓
573711286	141 [286]	1	✓	✓	✓	✓	✓	✓	✓	✓	✓	✓
573713135	57 [135]	3	✓	✓	✓	✓	✓	✓	✓	✓	✓	✓
573713155	68 [155]	3	✓	✓	✓	✓	✓	✓	✓	✓	✓	✓
573713175	79 [175]	3	✓	✓	✓	✓	✓	✓	✓	✓	✓	✓
573713200	93 [200]	3	✓	✓	✓	✓	✓	✓	✓	✓	✓	✓
573713286	141 [286]	3	✓	✓	✓	✓	✓	✓	✓	✓	✓	✓
573719135	57 [135]	9	✓	✓	✓	✓	✓	✓	✓	✓	✓	✓
573719155	68 [155]	9	✓	✓	✓	✓	✓	✓	✓	✓	✓	✓
573719175	79 [175]	9	✓	✓	✓	✓	✓	✓	✓	✓	✓	✓
573719200	93 [200]	9	✓	✓	✓	✓	✓	✓	✓	✓	✓	✓
573719286	141 [286]	9	✓	✓	✓	✓	✓	✓	✓	✓	✓	✓

K=115 [8.0] • 3/4" NPT • SIN TY4231 • H=58.7 mm [2-5/16"]												
Art. No.	T °C [°F]	F	CE	VDS	LPCB	FM	UL	CNBOP	VNIPO	PAVUS	T/S/U	BM OKF
573911135	57 [135]	1	✓	✓	✓	✓	✓	✓	✓	✓	✓	✓
573911155	68 [155]	1	✓	✓	✓	✓	✓	✓	✓	✓	✓	✓
573911175	79 [175]	1	✓	✓	✓	✓	✓	✓	✓	✓	✓	✓
573911200	93 [200]	1	✓	✓	✓	✓	✓	✓	✓	✓	✓	✓
573911286	141 [286]	1	✓	✓	✓	✓	✓	✓	✓	✓	✓	✓
573913135	57 [135]	3	✓	✓	✓	✓	✓	✓	✓	✓	✓	✓
573913155	68 [155]	3	✓	✓	✓	✓	✓	✓	✓	✓	✓	✓
573913175	79 [175]	3	✓	✓	✓	✓	✓	✓	✓	✓	✓	✓
573913200	93 [200]	3	✓	✓	✓	✓	✓	✓	✓	✓	✓	✓
573913286	141 [286]	3	✓	✓	✓	✓	✓	✓	✓	✓	✓	✓
573919135	57 [135]	9	✓	✓	✓	✓	✓	✓	✓	✓	✓	✓
573919155	68 [155]	9	✓	✓	✓	✓	✓	✓	✓	✓	✓	✓
573919175	79 [175]	9	✓	✓	✓	✓	✓	✓	✓	✓	✓	✓
573919200	93 [200]	9	✓	✓	✓	✓	✓	✓	✓	✓	✓	✓
573919286	141 [286]	9	✓	✓	✓	✓	✓	✓	✓	✓	✓	✓

K=57 [4.0] • 3/8" ISO • SIN TY2209 • H=55.0 mm [2-1/16"]												
Art. No.	T °C [°F]	F	CE	VDS	LPCB	FM	UL	CNBOP	VNIPO	PAVUS	T/S/U	BM OKF
573811135	57 [135]	1	✓	✓	✓	✓	✓	✓	✓	✓	✓	✓
573811155	68 [155]	1	✓	✓	✓	✓	✓	✓	✓	✓	✓	✓
573811175	79 [175]	1	✓	✓	✓	✓	✓	✓	✓	✓	✓	✓
573811200	93 [200]	1	✓	✓	✓	✓	✓	✓	✓	✓	✓	✓
573811286	141 [286]	1	✓	✓	✓	✓	✓	✓	✓	✓	✓	✓
573813135	57 [135]	3	✓	✓	✓	✓	✓	✓	✓	✓	✓	✓
573813155	68 [155]	3	✓	✓	✓	✓	✓	✓	✓	✓	✓	✓
573813175	79 [175]	3	✓	✓	✓	✓	✓	✓	✓	✓	✓	✓
573813200	93 [200]	3	✓	✓	✓	✓	✓	✓	✓	✓	✓	✓
573813286	141 [286]	3	✓	✓	✓	✓	✓	✓	✓	✓	✓	✓
573819135	57 [135]	9	✓	✓	✓	✓	✓	✓	✓	✓	✓	✓
573819155	68 [155]	9	✓	✓	✓	✓	✓	✓	✓	✓	✓	✓
573819175	79 [175]	9	✓	✓	✓	✓	✓	✓	✓	✓	✓	✓
573819200	93 [200]	9	✓	✓	✓	✓	✓	✓	✓	✓	✓	✓
573819286	141 [286]	9	✓	✓	✓	✓	✓	✓	✓	✓	✓	✓

TYCER TFP 03/07 Tyco reserves the right to change the contents without notice

Standard Coverage Sprinklers, Quick Response, [Recessed] Pendent

RU Спринклеры со стандартной зоной орошения, быстрое реагирование, [утопленные] с плоской розеткой

TR Normal kaplama alanlı sprinklerler, hızlı tepkili, [gömme] asagi bakan



TY-FRL



TFP 130



0.09 kg



Art. No. 560001849, W-Type 9
560001948, W-Type 10

[P.1.117]



Style 10, 20, 30 & 40

[P.1.107]

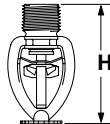

K=40 [2.8] • 1/2" NPT • SINTY1221 • H=68.3 mm [2-11/16"]

Art. No.	T	F
	°C [°F]	
589711165	74 [165]	1
589711212	100 [212]	1
589719165	74 [165]	9
589719212	100 [212]	9

K=80 [5.6] • 1/2" NPT • SINTY3221 • H=68.3 mm [2-11/16"]

Art. No.	T	F	CE	LPCB	FM	UL
	°C [°F]					
589721165	74 [165]	1	√	√	√	√
589721212	100 [212]	1	√	√	√	√
589729165	74 [165]	9	√	√	√	√
589729212	100 [212]	9	√	√	√	√

K=115 [8.0] • 3/4" NPT • SINTY4221 • H=74.6 mm [2-15/16"]

Art. No.	T	F	CE	FM	UL
	°C [°F]				
581721165	74 [165]	1	√	√	√
581721212	100 [212]	1	√	√	√
581729165	74 [165]	9	√	√	√
581729212	100 [212]	9	√	√	√

Standard Coverage Sprinklers, Quick Response, Conventional

RU Спринклеры со стандартной зоной орошения, быстрое реагирование, традиционные

TR Normal kaplama alanlı sprinklerler, hızlı tepkili, konvansiyonel



TFP 666



0.08 kg



Art. No. 568504001, W-Type 7
560006387, W-Type 6

[P.1.117]

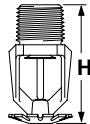

K=80 [5.6] • 1/2" NPT • SIN TY3631 • H=55.6 mm [2-3/16"]

Art. No.	T °C [°F]	F	CE	VDS	LPCB	UL	VNIIPO	PAVUS	T/S/U	BM OKF
573731135	57 [135]	1	√	√	√	√	√	√	√	√
573731155	68 [155]	1	√	√	√	√	√	√	√	√
573731175	79 [175]	1	√	√	√	√	√	√	√	√
573731200	93 [200]	1	√	√	√	√	√	√	√	√
573731286	141 [286]	1	√	√	√	√	√	√	√	√
573733135	57 [135]	3	√	√	√	√	√	√	√	√
573733155	68 [155]	3	√	√	√	√	√	√	√	√
573733175	79 [175]	3	√	√	√	√	√	√	√	√
573733200	93 [200]	3	√	√	√	√	√	√	√	√
573733286	141 [286]	3	√	√	√	√	√	√	√	√
573739135	57 [135]	9	√	√	√	√	√	√	√	√
573739155	68 [155]	9	√	√	√	√	√	√	√	√
573739175	79 [175]	9	√	√	√	√	√	√	√	√
573739200	93 [200]	9	√	√	√	√	√	√	√	√
573739286	141 [286]	9	√	√	√	√	√	√	√	√

K=115 [8.0] • 3/4" NPT • SIN TY4631 • H=57.2 mm [2-1/4"]

Art. No.	T °C [°F]	F	CE	VDS	LPCB	UL	VNIIPO	PAVUS	T/S/U	BM OKF
573931135	57 [135]	1	√	√	√	√	√	√	√	√
573931155	68 [155]	1	√	√	√	√	√	√	√	√
573931175	79 [175]	1	√	√	√	√	√	√	√	√
573931200	93 [200]	1	√	√	√	√	√	√	√	√
573931286	141 [286]	1	√	√	√	√	√	√	√	√
573933135	57 [135]	3	√	√	√	√	√	√	√	√
573933155	68 [155]	3	√	√	√	√	√	√	√	√
573933175	79 [175]	3	√	√	√	√	√	√	√	√
573933200	93 [200]	3	√	√	√	√	√	√	√	√
573933286	141 [286]	3	√	√	√	√	√	√	√	√
573939135	57 [135]	9	√	√	√	√	√	√	√	√
573939155	68 [155]	9	√	√	√	√	√	√	√	√
573939175	79 [175]	9	√	√	√	√	√	√	√	√
573939200	93 [200]	9	√	√	√	√	√	√	√	√
573939286	141 [286]	9	√	√	√	√	√	√	√	√

RU Спринклеры со стандартной зоной орошения, быстрое реагирование, [утопленные] горизонтальные настенные

TR Normal kaplama alanlı sprinklerler, hızlı tepkili, [gömme] yatay duvar tipi



TFP 176



0.08 kg



Art. No. 568504001, W-Type 7
560006387, W-Type 6

[P.1.117]



Style 10, 20, 30 & 40

[P.1.107]

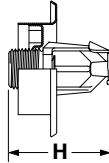

K=80 [5.6] • 1/2" NPT • SINTY3331 • H=55.6 mm [2-3/16"]

Art. No.	T °C [°F]	F	CE	LPCB	FM	UL	CNBOP	VNIPO	PAVUS	BM OKF
573781135	57 [135]	1	√	√	√	√	√	√	√	√
573781155	68 [155]	1	√	√	√	√	√	√	√	√
573781175	79 [175]	1	√	√	√	√	√	√	√	√
573781200	93 [200]	1	√	√	√	√	√	√	√	√
573781286	141 [286]	1	√	√	√	√	√	√	√	√
573783135	57 [135]	3	√	√	√	√	√	√	√	√
573783155	68 [155]	3	√	√	√	√	√	√	√	√
573783175	79 [175]	3	√	√	√	√	√	√	√	√
573783200	93 [200]	3	√	√	√	√	√	√	√	√
573783286	141 [286]	3	√	√	√	√	√	√	√	√
573789135	57 [135]	9	√	√	√	√	√	√	√	√
573789155	68 [155]	9	√	√	√	√	√	√	√	√
573789175	79 [175]	9	√	√	√	√	√	√	√	√
573789200	93 [200]	9	√	√	√	√	√	√	√	√
573789286	141 [286]	9	√	√	√	√	√	√	√	√

Standard Coverage Sprinklers, Quick Response, Horizontal Sidewall

RU Спринклеры со стандартной зоной орошения, быстрое реагирование, горизонтальные настенные

TR Normal kaplama alanlı sprinklerler, hızlı tepkili, yatay duvar tipi



TY-FRL



TFP 140



0.09 kg



[P.1.117]

Art. No. 560001849, W-Type 9

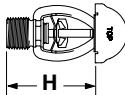

K=80 [5.6] • 1/2" NPT • SINTY3321 • H=68.3 mm [2-11/16"]

Art. No.	T	F	CE	FM	UL
	°C [°F]				
589461165	74 [165]	1	√	√	√
589461212	100 [212]	1	√	√	√
589469165	74 [165]	9	√	√	√
589469212	100 [212]	9	√	√	√

Standard Coverage Sprinklers, Quick Response, Vertical Sidewall

RU Спринклеры со стандартной зоной орошения, быстрое реагирование, вертикальные настенные

TR Normal kaplama alanlı sprinklerler, hızlı tepkili, dikey duvar tip



 TFP 176

 0.08 kg

 Art. No. 568504001, W-Type 7
560006387, W-Type 6
[P.1.117]

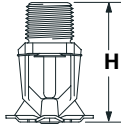

K=80 [5.6] • 1/2" NPT • SINTY3431 • H=55.6 mm [2-3/16"]

Art. No.	T °C [°F]	F	CE	LPCB	FM	UL	PAVUS
573751135	57 [135]	1	√	√	√	√	√
573751155	68 [155]	1	√	√	√	√	√
573751175	79 [175]	1	√	√	√	√	√
573751200	93 [200]	1	√	√	√	√	√
573751286	141 [286]	1	√	√	√	√	√
573753135	57 [135]	3	√	√	√	√	√
573753155	68 [155]	3	√	√	√	√	√
573753175	79 [175]	3	√	√	√	√	√
573753200	93 [200]	3	√	√	√	√	√
573753286	141 [286]	3	√	√	√	√	√
573759135	57 [135]	9	√	√	√	√	√
573759155	68 [155]	9	√	√	√	√	√
573759175	79 [175]	9	√	√	√	√	√
573759200	93 [200]	9	√	√	√	√	√
573759286	141 [286]	9	√	√	√	√	√

Standard Coverage Sprinklers, Standard & Quick Response, Pendent Concealed

RU Спринклеры со стандартной зоной орошения, стандартное и быстрое реагирование, скрытые с плоской розеткой

TR Normal kaplama alanlı sprinklerler, hızlı tepkili, aşağı bakan gizli tip



RFII



TFP 181



0.21 kg



Art. No. 560001075

[P.1.117]

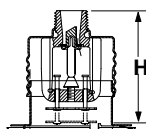

K=80 [5.6] • 1/2" NPT • SIN TY3551 • H=44.5-57.2 mm [1-3/4"-2-1/4"]

Art. No. Стандартный Normal	T °C [°F]	F	CE	LPCB	FM	UL	CNBOP	VNIPO
517903155	68 [155]	3	√	√	√	√	√	√
517903200	93 [200]	3	√	√	√	√	√	√
517904155	68 [155]	4	√	√	√	√	√	√
517904200	93 [200]	4	√	√	√	√	√	√
517909155	68 [155]	9	√	√	√	√	√	√
517909200	93 [200]	9	√	√	√	√	√	√

Max. 12.1 Bar [175 Psi]

K=80 [5.6] • 1/2" NPT • SIN TY3504 • H=44.5-57.2 mm [1-3/4"-2-1/4"]

Art. No. Стандартный Normal	T °C [°F]	F	UL
517963155	68 [155]	3	√
517963200	93 [200]	3	√
517964155	68 [155]	4	√
517964200	93 [200]	4	√
517969155	68 [155]	9	√
517969200	93 [200]	9	√

Max. 17.3 Bar [250 Psi]

K=80 [5.6] • 1/2" NPT • SIN TY3531 • H=44.5-57.2 mm [1-3/4"-2-1/4"]

Art. No. Оперативность Hızlı	T °C [°F]	F	CE	LPCB	FM	UL	CNBOP	VNIPO
517923155	68 [155]	3	√	√	√	√	√	√
517923200	93 [200]	3	√	√	√	√	√	√
517924155	68 [155]	4	√	√	√	√	√	√
517924200	93 [200]	4	√	√	√	√	√	√
517929155	68 [155]	9	√	√	√	√	√	√
517929200	93 [200]	9	√	√	√	√	√	√

Max. 12.1 Bar [175 Psi]

K=80 [5.6] • 1/2" NPT • SIN TY3505 • H=44.5-57.2 mm [1-3/4"-2-1/4"]

Art. No. Оперативность Hızlı	T °C [°F]	F	UL
517973155	68 [155]	3	√
517973200	93 [200]	3	√
517974155	68 [155]	4	√
517974200	93 [200]	4	√
517979155	68 [155]	9	√
517979200	93 [200]	9	√

Max. 17.3 Bar [250 Psi]

Other finishes available on request/

Другие варианты покрытия - по запросу/

Ayrı kaplamalar için özel taleplerinizi bekliyoruz

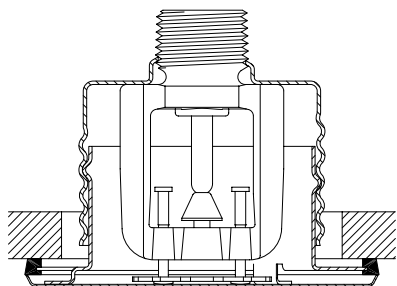

Clean Room Seal /Чистое уплотнение /Temiz oda kapaması

Art. No. Стандартный Normal	Kg	UL
569081001	0.01	√

TYCERTFP 03/07 Tyco reserves the right to change the contents without notice

RU Спринклеры с расширенной зоной орошения

TR Geniřletilmiş kaplama alanlı sprinklerler



EC-25

Standard Response

Стандартное реагирование
Normal tepkili

P. 1.028



EC-11 & EC-14

Standard/Quick Response, [Recessed]

Стандартное/быстрое реагирование, [утопленные]
Normal/ hızlı tepkili, [gömme]

P. 1.029



EC-8 & EC-5

Quick Response, [Recessed]

Быстрое реагирование, [утопленные]
Hızlı tepkili, [gömme]

P. 1.030



EPEC

Enhanced Protection Pendant

С плоской розеткой и усиленной защитой
Geliřtirilmiş korumaya sahip, ařađı bakan

P. 1.031



TY-FRB

Quick Response, [Recessed] Horizontal Sidewall

Быстрое реагирование, [утопленные] горизонтальные настенные
Hızlı tepkili, [gömme] yatay duvar tipi

P. 1.032



EC-5

Quick Response, [Recessed] Horizontal Sidewall

Быстрое реагирование, [утопленные] горизонтальные настенные
Hızlı tepkili, [gömme] yatay duvar tipi

P. 1.032



TY-FRL

Quick Response, Horizontal Sidewall

Быстрое реагирование, горизонтальные настенные
Hızlı tepkili, yatay duvar tipi

P. 1.033



ELO-SW20 ECON

Standard Response, ELO Horizontal Sidewall

Стандартное реагирование, горизонтальные настенные ELO
Normal tepkili, ekstra geniř orifis, yatay duvar tipi

P. 1.034



ELO-SW40 ECON

Standard Response, ELO Horizontal Sidewall

Стандартное реагирование, горизонтальные настенные ELO
Normal tepkili, ekstra geniř orifis, yatay duvar tipi

P. 1.034



RF-II & ELOC

Pendent Concealed

Скрытые с плоской розеткой
Ařađı bakan, gizli

P. 1.035



CHEC

Horizontal Sidewall Concealed

Горизонтальные настенные, скрытые
Yatay duvar tipi, gizli

P. 1.036

Extended Coverage Area/Density Sprinkler, Standard Response, EC-25

RU Спринклеры с расширенной зоной орошения типа "площадь/интенсивность", стандартное реагирование, EC-25

TR Genişletilmiş kaplama alanlı sprinklerler, normal tepkili, Yogun Akisli, yukari bakan

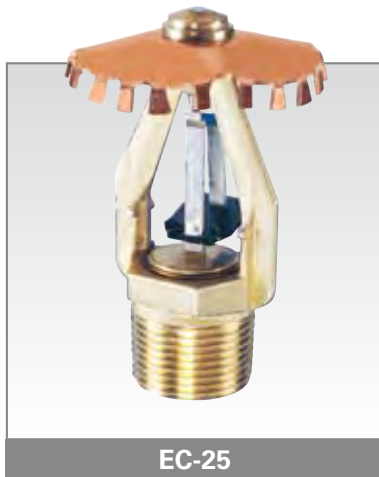

EC-25

 TFP 213

 0.20 kg

 Art. No. 568721025, W-Type 1
[P.1.117]

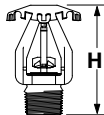

K=363[25.2] • 1" ISO • SINTY9128 • H=95.3 [3-3/4"]

Art. No.	T °C [°F]	F	FM	UL
584511165	74 [165]	1	√	√
584511214	101 [214]	1	√	√

K=363[25.2] • 1" NPT • SINTY9128 • H=95.3 [3-3/4"]

Art. No.	T °C [°F]	F	FM	UL
584501165	74 [165]	1	√	√
584501214	101 [214]	1	√	√

RU Спринклеры с расширенной зоной орошения, стандартное и быстрое реагирование, [утопленные] EC-11 и EC-14

TR Genişletilmiş kaplama alanlı sprinklerler, normal/hızlı tepkili, [gömme] asagi , yukari bakan



EC-11 & EC-14



TFP 220



0.15 kg



Art. No. 568951001, W-Type 3
566657001, W-Type 22

[P.1.117]



Style 30-40

[P.1.107]

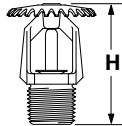

K=160 [11.2] • 3/4" NPT • SIN TY5237 • H=61.9 mm [2-7/16"]				
Art. No. Pendent С плоской розеткой Аşağı bakan	T °C [°F]	F	FM*	UL
518931135	57 [135]	1	√	√
518931155	68 [155]	1	√	√
518931175	79 [175]	1	√	√
518931200	93 [200]	1	√	√
518934135	57 [135]	4	√	√
518934155	68 [155]	4	√	√
518934175	79 [175]	4	√	√
518934200	93 [200]	4	√	√
518939135	57 [135]	9	√	√
518939155	68 [155]	9	√	√
518939175	79 [175]	9	√	√
518939200	93 [200]	9	√	√

K=160 [11.2] • 3/4" NPT • SIN TY5137 • H=61.9 mm [2-7/16"]				
Art. No. Upright С вогнутой розеткой Yukarı bakan	T °C [°F]	F	FM*	UL
518941135	57 [135]	1	√	√
518941155	68 [155]	1	√	√
518941175	79 [175]	1	√	√
518941200	93 [200]	1	√	√
518944135	57 [135]	4	√	√
518944155	68 [155]	4	√	√
518944175	79 [175]	4	√	√
518944200	93 [200]	4	√	√
518949135	57 [135]	9	√	√
518949155	68 [155]	9	√	√
518949175	79 [175]	9	√	√
518949200	93 [200]	9	√	√

K=200 [14.0] • 3/4" NPT • SIN TY6237 • H=61.9 mm [2-7/16"]				
Art. No. Pendent С плоской розеткой Аşağı bakan	T °C [°F]	F	FM*	UL
518951135	57 [135]	1	√	√
518951155	68 [155]	1	√	√
518951175	79 [175]	1	√	√
518951200	93 [200]	1	√	√
518951286	141 [286]	1	√	√
518954135	57 [135]	4	√	√
518954155	68 [155]	4	√	√
518954175	79 [175]	4	√	√
518954200	93 [200]	4	√	√
518954286	141 [286]	4	√	√
518959135	57 [135]	9	√	√
518959155	68 [155]	9	√	√
518959175	79 [175]	9	√	√
518959200	93 [200]	9	√	√
518959286	141 [286]	9	√	√

K=200 [14.0] • 3/4" NPT • SIN TY6137 • H=61.9 mm [2-7/16"]					
Art. No. Upright С вогнутой розеткой Yukarı bakan	T °C [°F]	F	FM*	UL	VNIPO
518961135	57 [135]	1	√	√	
518961155	68 [155]	1	√	√	√
518961175	79 [175]	1	√	√	
518961200	93 [200]	1	√	√	
518961286	141 [286]	1	√	√	
518964135	57 [135]	4	√	√	
518964155	68 [155]	4	√	√	√
518964175	79 [175]	4	√	√	
518964200	93 [200]	4	√	√	
518964286	141 [286]	4	√	√	
518969135	57 [135]	9	√	√	
518969155	68 [155]	9	√	√	√
518969175	79 [175]	9	√	√	
518969200	93 [200]	9	√	√	
518969286	141 [286]	9	√	√	

*FM: depending on design criteria [see TFP220]

*FM: зависит от критериев конструирования [см. TFP220]

*FM: dizayn kriterlere göre değişir [bkz. TFP200]

TYCER TFP 03/07 Tyco reserves the right to change the contents without notice

Extended Coverage Sprinkler, Quick Response, [Recessed] EC-8

RU Спринклеры с расширенной зоной орошения, быстрое реагирование, [утопленные] EC-8

TR Genişletilmiş kaplama alanlı sprinklerler, hızlı tepkili, [gömme] asagi bakan

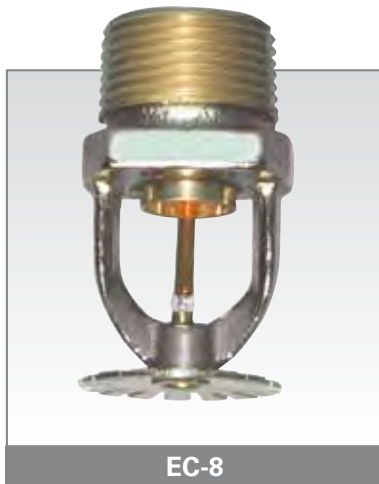

TFP 223



0.15 kg



Art. No. 568951001, W-Type 3

[P.1.117]



Style 30 & 40

[P.1.107]

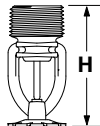

K=115 [8.0] • 3/4" NPT • SINTY4232 • H=54.0 mm [2-1/8"]

Art. No.	T	F	UL	FM
	°C [°F]			
508011135	57 [135]	1	√	√
508011155	68 [155]	1	√	√
508014135	57 [135]	4	√	√
508014155	68 [155]	4	√	√
508019135	57 [135]	9	√	√
508019155	68 [155]	9	√	√



TFP 228



0.15 kg



Art. No. 568504001, W-Type 7
560006387, W-Type 6

[P.1.117]



Style 50

[P.1.107]

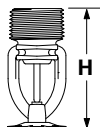

K=80 [5.6] • 1/2" NPT • SINTY3232 • H=52.4 mm [2-1/16"]

Art. No.	T	F	UL	FM
	°C [°F]			
510511135	57 [135]	1	√	
510511155	68 [155]	1	√	√
510514135	57 [135]	4	√	√
510514155	68 [155]	4	√	√
510519135	57 [135]	9	√	√
510519155	68 [155]	9	√	√

Enhanced Protection Extended Coverage Pendant Sprinkler

RU Спринклер с расширенной областью орошения, с плоской розеткой и усиленной защитой

TR Geliştirilmiş korumaya sahip, genişletilmiş kaplama alanlı aşağı bakan sprinklerler



 TFP 221

 0.100 kg

 Art. No. 568951001, W-Type 3
[P.1.117]

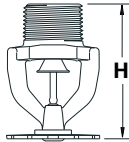

K=115 [8.0] • 3/4" NPT • SINTY4237 • H=64 mm

Art. No.	T °C [°F]	F	LPCB
551011135	57 [135]	1	√
551011155	68 [155]	1	√
551011175	79 [175]	1	√
551013135	57 [135]	3	√
551013155	68 [155]	3	√
551013175	79 [175]	3	√
551019135	57 [135]	9	√
551019155	68 [155]	9	√
551019175	79 [175]	9	√

Extended Coverage Sprinkler, Quick Response, [Recessed] Horizontal Sidewall

RU Спринклер с расширенной областью орошения, быстрого реагирования, [утопленный] горизонтальный настенный

TR Genişletilmiş kaplama alanlı hızlı tepkili, [gömme] yatay duvar tipi



TFP 296

0.08 kg

Art. No. 560006387, W-Type 6
568504001, W-Type 7
[P.1.117]

Style 10, 20, 30 & 40
[P.1.107]

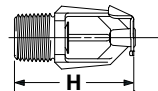

K=80 [5.6] • 1/2" NPT • SIN TY3332 • H=55.6 mm [2-3/16"]							
Art. No.	T °C [°F]	F	VDS	FM	UL	PAVUS	T/SU
573761135	57 [135]	1	√	√	√	√	√
573761155	68 [155]	1	√	√	√	√	√
573763135	57 [135]	3	√	√	√	√	√
573763155	68 [155]	3	√	√	√	√	√
573769135	57 [135]	9	√	√	√	√	√
573769155	68 [155]	9	√	√	√	√	√

K=115 [8.0] • 3/4" NPT • SIN TY4332 • H=57.2 mm [2-1/4"]							
Art. No.	T °C [°F]	F	UL	FM	CNBOP	PAVUS	
573961135	57 [135]	1	√	√	√	√	
573961155	68 [155]	1	√	√	√	√	
573963135	57 [135]	3	√	√	√	√	
573963155	68 [155]	3	√	√	√	√	
573969135	57 [135]	9	√	√	√	√	
573969155	68 [155]	9	√	√	√	√	



TFP 298

0.08 kg

Art. No. 560006387, W-Type 6
568504001, W-Type 7
[P.1.117]

Style 50
[P.1.107]

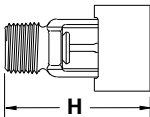

K=80 [5.6] • 1/2" NPT • SIN TY3302 • H=63.5 mm [2-8/16"]				
Art. No.	T °C [°F]	F	UL	FM
510531135	57 [135]	1	√	√
510531155	68 [155]	1	√	√
510531200	93 [200]	1	√	√
510533135	57 [135]	3	√	√
510533155	68 [155]	3	√	√
510533200	93 [200]	3	√	√
510539135	57 [135]	9	√	√
510539155	68 [155]	9	√	√
510539200	93 [200]	9	√	√

TYCERTFP 03/07 Tyco reserves the right to change the contents without notice

Extended Coverage Sprinkler, Quick Response, Horizontal Sidewall

RU Спринклер с расширенной областью орошения, быстрого реагирования, [утопленный] горизонтальный настенный

TR Genişletilmiş kaplama alanlı hızlı tepkili, [gömme] yatay duvar tipi



TFP 280



0.10 kg



Art. No. 560001849, W-Type 9
[P.1.117]

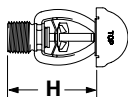

K=80 [5.6] • 1/2" NPT • SINTY3322 • H=71.4 mm [2-13/16"]

Art. No.	T	F	FM	UL
	°C [°F]			
589701140	60 [140]	1	√	√
589701165	74 [165]	1	√	√
589701140	60 [140]	9	√	√
589701165	74 [165]	9	√	√

K=115 [8.0] • 3/4" NPT • SINTY4322 • H=71.4 mm [2-13/16"]

Art. No.	T	F	FM	UL
	°C [°F]			
581701165	74 [165]	1	√	√
581701165	74 [165]	9	√	√

- RU** Спринклер с расширенной областью орошения, стандартного реагирования, горизонтальный настенный ELO
- TR** Genişletilmiş kaplama alanlı normal tepkili, extra geniş orifisli [gömmе] yatay duvar tipi



ELO SW-20 ECOH



TFP 230



0.10 kg



Art. No. 5608951001, W-Type 3

[P.1.117]

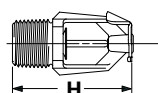

K=160 [11.2] • 3/4" NPT • SINTY5332 • H=79,4 mm [3-1/8"]

Art. No.	T °C [°F]	F	UL
510721155	68 [155]	1	√
510721200	93 [200]	1	√
510724155	68 [155]	4	√
510724200	93 [200]	4	√
510729155	68 [155]	9	√
510729200	93 [200]	9	√



ELO SW-24 ECOH



TFP 230



0.10 kg



Art. No. 568951001, W-Type 3

[P.1.117]

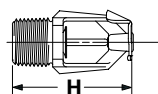

K=160 [11.2] • 3/4" NPT • SINTY5337 • H=79,4 mm [3-1/8"]

Art. No.	T °C [°F]	F	UL
510731200	93 [200]	1	√
510734200	93 [200]	4	√
510739200	93 [200]	9	√

Extended Coverage Sprinklers, Pendent Concealed

RU Спринклер с расширенной областью орошения, скрытые с плоской розеткой

TR Geniřletilmiş kaplama alanlı, ařađı bakan, gizli



 TFP 260

 0.21 kg

 Art. No. 560001075
[P.1.117]

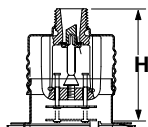

K=80 [5.6] • 1/2" NPT • SIN TY3532 • H=44.5-57.2 mm [1-3/4"-2-1/4"]

Art. No. Standard/Quick Стандартное/быстрое Normal/ hızlı	T °C [°F]	F	UL
517943155	68 [155]	3	√
517943200	93 [200]	3	√
517944155	68 [155]	4	√
517944200	93 [200]	4	√
517949155	68 [155]	9	√
517949200	93 [200]	9	√

Max. 12.1 bar [175 psi]

Other finishes available on request/

Другие варианты покрытия - по запросу/

Ayrı kaplamalar için özel taleplerinizi bekliyoruz



 TFP 250

 0.21 kg

 Art. No. 560001265
[P.1.117]

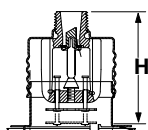

K=160 [11.2] • 3/4" NPT • SIN TY5522 • H=54.0 mm [2-1/8"]

Art. No. Standard/Quick Стандартное/быстрое Normal/ hızlı	T °C [°F]	F	UL
507013160	71 [160]	3	√
507013212	100 [212]	3	√
507014160	71 [160]	4	√
507014212	100 [212]	4	√
507019160	71 [160]	9	√
507019212	100 [212]	9	√

Max. 12.1 bar [175 psi]

Other finishes available on request/

Другие варианты покрытия - по запросу/

Ayrı kaplamalar için özel taleplerinizi bekliyoruz

Clean Room Seal • Чистое уплотнение Temiz oda kapaması

Art. No. Standard Стандартный Normal	Kg	UL
569081001	0.01	√

TYCERTFP 03/07 Tyco reserves the right to change the contents without notice

RU Спринклеры с расширенной областью орошения, горизонтальные настенные, скрытые

TR Genişletilmiş kaplama alanlı, yatay duvar tipi, gizli

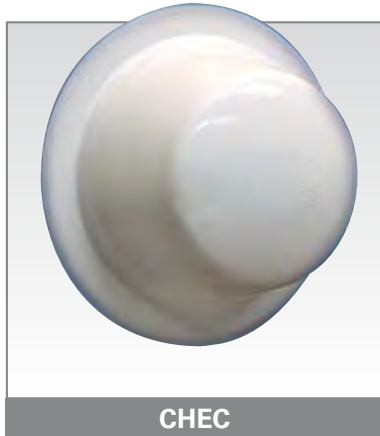

 TFP 265

 0.21 kg

 Art. No. 568504001, W-Type 7
[P.1.117]

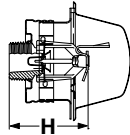

K=115 [8.0] • 3/4" NPT • SINTY4332 • H=65.1-77.8 mm [2-9/16"-3-1/16"]

Art. No. Quick Оперативность Hızlı	T °C [°F]	F	FM	UL	BM OKF
513963135	57 [135]	3	√	√	√
513963155	68 [155]	3	√	√	√
513964135	57 [135]	4	√	√	√
513964155	68 [155]	4	√	√	√
513969135	57 [135]	9	√	√	√
513969155	68 [155]	9	√	√	√

Other finishes available on request/

Другие варианты покрытия - по запросу/

Ayrı kaplamalar için özel taleplerinizi bekliyoruz

Storage Sprinklers

RU Спринклеры для складских помещений

TR Depo tipi sprinklerler



ESFR-25

Quick Response, Pendent

Быстрого реагирования, с плоской розеткой
Hızlı tepkili, aşağı bakan

P. 1.039



ESFR-17

Quick Response, Pendent

Быстрого реагирования, с плоской розеткой
Hızlı tepkili, aşağı bakan

P. 1.040



ESFR-17

Quick Response, Upright

Быстрого реагирования, с вогнутой розеткой
Hızlı tepkili, yukarı bakan

P. 1.040



ESFR-1

Quick Response, Pendent

Быстрого реагирования, с плоской розеткой
Hızlı tepkili, aşağı bakan

P. 1.041



LD

Standard Response, Large Drop

Стандартное реагирование, с большими каплями
Normal tepkili, iri damlalı

P. 1.042



ULTRA K17

Standard Response, Upright

Стандартное реагирование, с вогнутой розеткой
Normal tepkili, yukarı bakan

P. 1.042



K17-231

Standard Response, Pendent

Стандартное реагирование, с плоской розеткой
Normal tepkili, aşağı bakan

P. 1.043



K17-231

Standard Response, Upright

Стандартное реагирование, с вогнутой розеткой
Normal tepkili, yukarı bakan

P. 1.043



ELO-231B

Standard Response, Pendent

Стандартное реагирование, с плоской розеткой
Normal tepkili, aşağı bakan

P. 1.044



ELO-231B

Standard Response, Upright

Стандартное реагирование, с вогнутой розеткой
Normal tepkili, yukarı bakan

P. 1.044



ELO-231

Standard Response, Pendent

Стандартное реагирование, с плоской розеткой
Normal tepkili, aşağı bakan











P. 1.045

TYCERTFP 03/07 Tyco reserves the right to change the contents without notice

Storage Sprinklers

RU Спринклеры для складских помещений

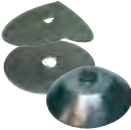
TR Depo tipi sprinklerler

 ELO-231	Standard Response, Upright Стандартное реагирование, с вогнутой розеткой Normal tepkili, yukarı bakan	P. 1.045
 ELO-231 FRB	Quick Response, Pendent Быстрого реагирования, с плоской розеткой Hızlı tepkili, aşağı bakan	P. 1.046
 ELO-231 FRB	Quick Response, Upright Быстрого реагирования, с вогнутой розеткой Hızlı tepkili, yukarı bakan	P. 1.046
 TY-B	Standard Response, Intermediate Level, Upright W/Shield Стандартное реагирование, промежуточный уровень, с вогнутой розеткой и щитком Normal tepkili, ara seviyeler için, yukarı bakan, koruyucu plakalı	P. 1.047
 TY-L	Standard Response, Intermediate Level, Upright W/Shield Стандартное реагирование, промежуточный уровень, с вогнутой розеткой и щитком Normal tepkili, ara seviyeler için, yukarı bakan, koruyucu plakalı	P. 1.048
 TY-FRB	Quick Response, Intermediate Level, Upright W/Shield Быстрое реагирование, промежуточный уровень, с вогнутой розеткой и щитком Hızlı tepkili, ara seviyeler için, yukarı bakan, koruyucu plakalı	P. 1.049
 TY-FRL	Quick Response, Intermediate Level, Upright W/Shield Быстрое реагирование, промежуточный уровень, с вогнутой розеткой и щитком Hızlı tepkili, ara seviyeler için, yukarı bakan, koruyucu plakalı	P. 1.049
 TY-B & TY-FRB	Intermediate Level, Shield for Pendent Sprinklers Промежуточный уровень, щиток для спринклеров с плоской розеткой Ara seviyeler için, aşağı bakan sprinklerlere uygun koruyucu plakalar	P. 1.050
 TY-B & TY-FRB	Intermediate Level, Shield for Pendent Sprinklers Промежуточный уровень, щиток для спринклеров с плоской розеткой Ara seviyeler için, aşağı bakan sprinklerlere uygun koruyucu plakalar	P. 1.050
 TY-B & TY-FRB	Intermediate Level, Shield for Pendent Sprinklers Промежуточный уровень, щиток для спринклеров с плоской розеткой Ara seviyeler için, aşağı bakan sprinklerlere uygun koruyucu plakalar	P. 1.051
 TY-L & TY-FRL	Intermediate Level, Shield for Pendent Sprinklers Промежуточный уровень, щиток для спринклеров с плоской розеткой Ara seviyeler için, aşağı bakan sprinklerlere uygun koruyucu plakalar	P. 1.052

TYCERTFP 03/07 Tyco reserves the right to change the contents without notice

Storage Sprinklers, Quick Response, ESFR-25

RU Спринклеры для складских помещений, быстрого реагирования, ESFR-25

TR Depo tipi sprinklerler, hızlı tepkili, ESFR-25

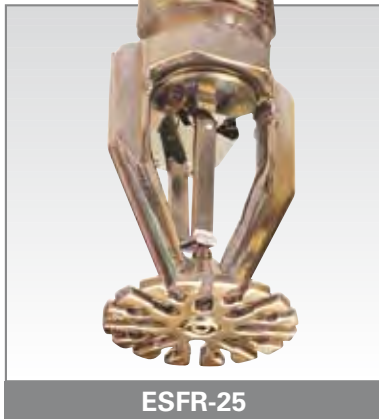

TFP 312



0.20 kg



[P.1.117]

Art. No. 568721025, W-Type 1

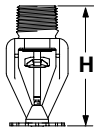

K=363 [25.2] • 1" ISO • SIN TY9226 • H=96.8 mm [3-13/16"]

Art. No. Pendent С плоской розеткой Аşağı bakan	T °C [°F]	F	VDS	LPCB	FM	UL	CNBOP	VNIPO	PAVUS	T/S/U
584421165	74 [165]	1	√	√	√	√	√	√	√	√
584421214	101 [214]	1	√	√	√	√	√	√	√	√

K=363 [25.2] • 1" NPT • SIN IP9226 • H=96.8 mm [3-13/16"]

Art. No. Pendent С плоской розеткой Аşağı bakan	T °C [°F]	F	VDS	LPCB	FM	UL	CNBOP	VNIPO	PAVUS	T/S/U
584411165	74 [165]	1	√	√	√	√	√	√	√	√
584411214	101 [214]	1	√	√	√	√	√	√	√	√

Storage Sprinklers, Quick Response, ESFR-17

RU Спринклеры для складских помещений, быстрого реагирования, ESFR-17

TR Depo tipi sprinklerler, hızlı tepkili, ESFR-17

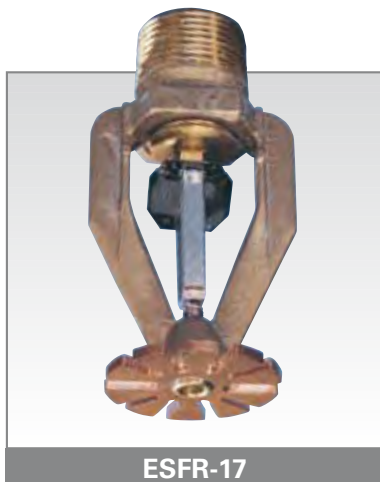

ESFR-17

TFP 315

0.17 kg

Art. No. 560010686, W-Type 21
[P.1.117]

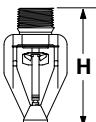

K=242 [16.8] • 3/4" NPT • SIN TY7226 • H=90.5 mm [3-9/16"]

Art. No. Pendent С плоской розеткой Аşağı bakan	T °C [°F]	F	FM	UL	LPCB	CNBOP	PAVUS	T/S/U	VNIIPO	VDS
584451165	74 [165]	1	√	√	√	√	√	√	√	√
584451214	101 [214]	1	√	√	√	√	√	√	√	√



ESFR-17

TFP 316

0.17 kg

Art. No. 560010686, W-Type 21

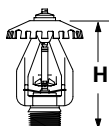

K=242 [16.8] • 3/4" NPT • SIN TY7126 • H=92.1 mm [3-5/8"]

Art. No. Upright С волгнутой розеткой Yukarı bakan	T °C [°F]	F	FM	UL	PAVUS	CNBOP	T/S/U	VNIIPO
584471165	74 [165]	1	√	√	√	√	√	√
584471214	101 [214]	1	√	√	√	√	√	√

TYCERTFP 03/07 Tyco reserves the right to change the contents without notice

Storage Sprinklers, Quick Response, ESFR-1

RU Спринклеры для складских помещений, быстрого реагирования, ESFR-1

TR Depo tipi sprinklerler, hızlı tepkili, ESFR-1



 **TFP 318**

 **0.17 kg**

 **Art. No. 568721001, W-Type 2**
[P.1.117]

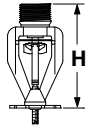

K=200 [14.0] • 3/4" NPT • SIN TY6226 • H=90.5 mm [3-9/16"]

Art. No. Pendent С плоской розеткой Aşağı bakan	T °C [°F]	F	VDS	LPCB	FM	UL	CNBP	PAVUS	T/SU	BM OKF
584401165	74 [165]	1	√	√	√	√	√	√	√	√
584401214	101 [214]	1	√	√	√	√	√	√	√	√

Storage Sprinklers, Standard Response, Large Drop, LD

RU Спринклеры для складских помещений, стандартного реагирования, с большими каплями, LD

TR Depo tipi sprinklerler, normal tepkili, iri damlalı, LD

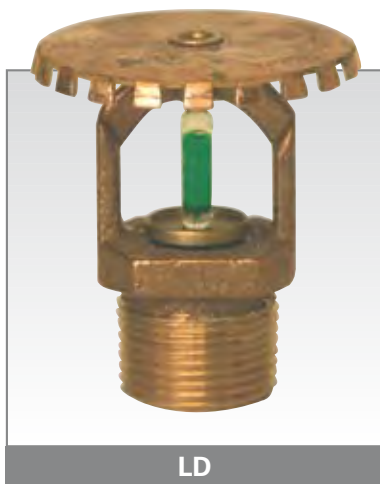

LD

 TFP 335

 0.17 kg

 Art. No. 568951001, W-Type 3
[P.1.117]

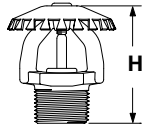

K=160 [11.2] • 3/4" NPT • SINTY5153 • H=60.3 mm [2-3/4"]

Art. No. Upright Свогнутой розеткой Yukarı bakan	T °C [°F]	F	UL
504002155	68 [155]	1	√
504002200	93 [200]	1	√
504002286	141 [286]	1	√

Storage Sprinklers, Standard Response, Upright, Ultra K17

RU Спринклеры для складских помещений, стандартного реагирования, с вогнутой розеткой, Ultra K17

TR Depo tipi sprinklerler, normal tepkili, yukarı bakan, Ultra K17



ULTRA K17

 TFP 330

 0.15 kg

 Art. No. 568921001, W-Type 8
[P.1.117]

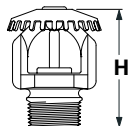

K=242 [16.8] • 3/4" NPT • SINTY7153 • H=60.3 mm [2-3/8"]

Art. No. Upright Свогнутой розеткой Yukarı bakan	T °C [°F]	F	FM	UL
518871155	68 [155]	1	√	
518871200	93 [200]	1	√	√
518871286	141 [286]	1	√	√

Storage Sprinklers, Standard Response, K17-231

RU Спринклеры для складских помещений, стандартного реагирования, K17-231

TR Depo tipi sprinklerler, normal tepkili, K17-231



K17-231



TFP 332



0.17 kg



[P.1.117]

Art. No. 568921001, W-Type 8

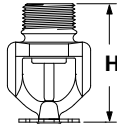

K=242 [16.8] • 3/4" NPT • SINTY7251 • H=60.3 mm [2-3/8"]

Art. No. Pendent С плоской розеткой Aşağı bakan	T °C [°F]	F	UL
518891155	68 [155]	1	√
518891200	93 [200]	1	√
518891286	141 [286]	1	√

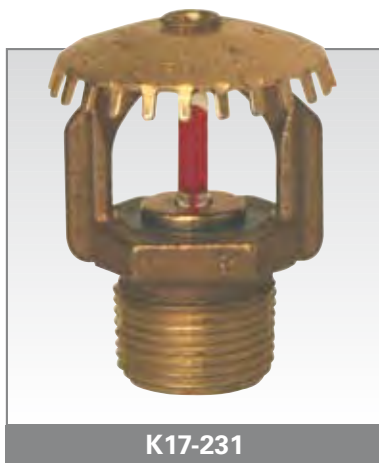

K17-231



TFP 332



0.17 kg



[P.1.117]

Art. No. 568921001, W-Type 8

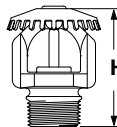

K=242 [16.8] • 3/4" NPT • SINTY7151 • H=60.3 mm [2-3/8"]

Art. No. Upright С вогнутой розеткой Yukarı bakan	T °C [°F]	F	FM	UL
518881155	68 [155]	1	√	√
518881200	93 [200]	1	√	√
518881286	141 [286]	1	√	√

RU Спринклеры для складских помещений, стандартного реагирования, ELO-231B

TR Depo tipi sprinklerler, normal tepkili, ELO-231B

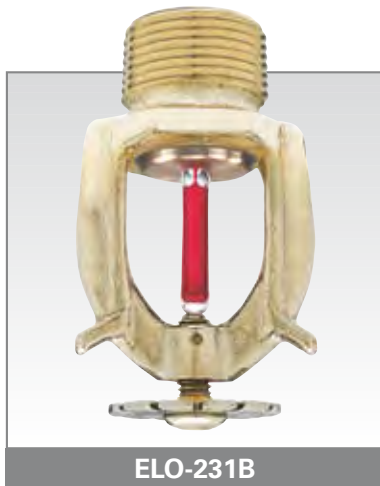

ELO-231B



TFP 342



0.17 kg



[P.1.117]

Art. No. 568951001, W-Type 3

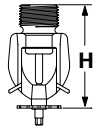

K=160 [11.2] • 3/4" NPT • SINTY5251 • H=71.4 mm [2-13/16"]

Art. No. Pendent С плоской розеткой Аşağı bakan	T °C [°F]	F	FM	UL
505121155	68 [155]	1	√	√
505121200	93 [200]	1	√	√
505121286	141 [286]	1	√	√



ELO-231B



TFP 342



0.17 kg



[P.1.117]

Art. No. 568951001, W-Type 3

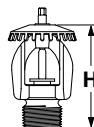

K=160 [11.2] • 1/2" NPT • SINTY5851 • H=71.4 mm [2-13/16"]

Art. No. Upright Свогнутой розеткой Yukarı bakan	T °C [°F]	F	FM	UL
505011155	68 [155]	1	√	√
505011200	93 [200]	1	√	√
505011286	141 [286]	1	√	√

K=160 [11.2] • 3/4" NPT • SINTY5151 • H=71.4 mm [2-13/16"]

Art. No. Upright Свогнутой розеткой Yukarı bakan	T °C [°F]	F	FM	UL
505101155	68 [155]	1	√	√
505101200	93 [200]	1	√	√
505101286	141 [286]	1	√	√

Storage Sprinklers, Standard Response, ELO-231

RU Спринклеры для складских помещений, стандартного реагирования, ELO-231

TR Depo tipi sprinklerler, normal tepkili, ELO-231



ELO-231

 TFP 340

 0.17 kg

 Art. No. 568951001, W-Type 3
[P.1.117]

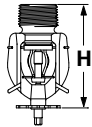

K=160 [11.2] • 3/4" NPT • SINTY5211 • H=71.4 mm [2-13/16"]

Art. No. Pendent С плоской розеткой Аşağı bakan	T °C [°F]	F	FM	UL
501121165	74 [165]	1	√	√
501121212	100 [212]	1	√	√
501121286	141 [286]	1	√	√



ELO-231

 TFP 340

 0.17 kg

 Art. No. 568951001, W-Type 3
[P.1.117]

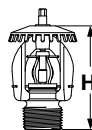

K=160 [11.2] • 1/2" NPT • SINTY5811 • H=71.4 mm [2-13/16"]

Art. No. Upright Свогнутой розеткой Yukarı bakan	T °C [°F]	F	FM	UL
502101165	74 [165]	1	√	√
502101212	100 [212]	1	√	√
502101286	141 [286]	1	√	√

K=160 [11.2] • 3/4" NPT • SINTY5111 • H=71.4 mm [2-13/16"]

Art. No. Upright Свогнутой розеткой Yukarı bakan	T °C [°F]	F	FM	UL
501101165	74 [165]	1	√	√
501101212	100 [212]	1	√	√
501101286	141 [286]	1	√	√

TYCERTFP 03/07 Tyco reserves the right to change the contents without notice

RU Спринклеры для складских помещений, быстрого реагирования, ELO-231 FRB

TR Depo tipi sprinklerler, hızlı tepkili, ELO-231 FRB



ELO-231 FRB

 TFP 344

 0.17 kg

 Art. No. 568951001, W-Type 3
[P.1.117]

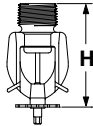

K=160 [11.2] • 3/4" NPT • SINTY5231 • H=71.4 mm [2-13/16"]

Art. No. Pendent С плоской розеткой Aşağı bakan	T °C [°F]	F	FM	UL
505021155	68 [155]	1	√	√
505021200	93 [200]	1	√	√
505021286	141 [286]	1	√	√

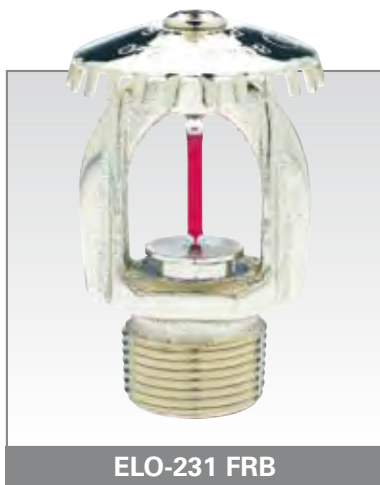

ELO-231 FRB

 TFP 344

 0.17 kg

 Art. No. 568951001, W-Type 3
[P.1.117]

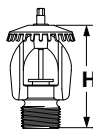

K=160 [11.2] • 3/4" NPT • SINTY5131 • H=71.4 mm [2-13/16"]

Art. No. Upright Свагнутой розеткой Yukarı bakan	T °C [°F]	F	FM	UL
505001155	68 [155]	1	√	√
505001200	93 [200]	1	√	√
505001286	141 [286]	1	√	√

Storage Sprinklers, Standard Response, Intermediate Level, Upright W/Shield

RU Спринклеры для складских помещений, стандартного реагирования, промежуточный уровень, с вогнутой розеткой и щитком

TR Depo tipi sprinklerler, normal tepkili, ara seviyeler için, yukarı bakan, koruyucu plakalı



TFP 351



0.120 kg



Art. No. 560006387, W-Type 6

[P.1.117]

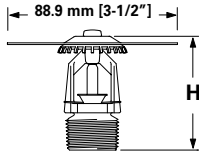

K=80 [5.6] • 1/2" NPT • SINTY3153 • H=60.3 mm [2-3/8"]

Art. No.	T °C [°F]	F	FM	UL
575331135	57 [135]	1	√	√
575331155	68 [155]	1	√	√
575331175	79 [175]	1	√	√
575331200	93 [200]	1	√	√
575331286	141 [286]	1	√	√
575331360	182 [360]	1	√	√
575336155	68 [155]	6	√	√
575336175	79 [175]	6	√	√
575336200	93 [200]	6	√	√
575336286	141 [286]	6	√	√

K=115 [8.0] • 3/4" NPT • SINTY4153 • H=61.9 mm [2-7/16"]

Art. No.	T °C [°F]	F	FM	UL
575431135	57 [135]	1	√	√
575431155	68 [155]	1	√	√
575431175	79 [175]	1	√	√
575431200	93 [200]	1	√	√
575431286	141 [286]	1	√	√
575431360	182 [360]	1	√	√
575436155	68 [155]	6	√	√
575436175	79 [175]	6	√	√
575436200	93 [200]	6	√	√
575436286	141 [286]	6	√	√

Storage Sprinklers, Standard Response, Intermediate Level, Upright W/Shield

RU Спринклеры для складских помещений, стандартного реагирования, промежуточный уровень, с вогнутой розеткой и щитком

TR Depo tipi sprinklerler, normal tepkili, ara seviyeler için, yukarı bakan, koruyucu plakalı



TY-L



TFP 350



0.130 kg



Art. No. 560001849, W-Type 9
[P.1.117]

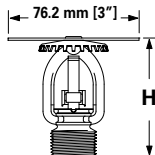

K=80 [5.6] • 1/2" NPT • SIN TY3113 • H=68.3 mm [2-11/16"]

Art. No.	T °C [°F]	F	FM	UL
532531135	57 [135]	1	√	√
532531165	74 [165]	1	√	√
532531212	100 [212]	1	√	√
532531280	138 [280]	1	√	√

K=115 [8.0] • 3/4" NPT • SIN TY4113 • H=69.9 mm [2-3/4"]

Art. No.	T °C [°F]	F	FM	UL
531531135	57 [135]	1	√	√
531531165	74 [165]	1	√	√
531531212	100 [212]	1	√	√
531531280	138 [280]	1	√	√

Storage Sprinklers, Quick Response, Intermediate Level, Upright W/Shield

RU Спринклер для складских помещений, быстрого реагирования, промежуточный уровень, с согнутой розеткой и щитком

TR Depo Tipi ,ara seviyeler icin hızlı tepkili, yukari bakan koruyucu plakali tipi



TFP 356

0.120 kg

Art. No. 560006387, W-Type 6
[P.1.117]

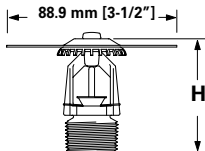

K=80 [5.6] • 1/2" NPT • SINTY3133 • H=60.3 mm [2-3/8"]

Art. No.	T °C [°F]	F	FM	UL
573331135	57 [135]	1	√	√
573331155	68 [155]	1	√	√
573331175	79 [175]	1	√	√
573331200	93 [200]	1	√	√
573331286	141 [286]	1	√	√

K=115 [8.0] • 3/4" NPT • SINTY4133 • H=61.9 mm [2-7/16"]

Art. No.	T °C [°F]	F	FM	UL
573431135	57 [135]	1	√	√
573431155	68 [155]	1	√	√
573431175	79 [175]	1	√	√
573431200	93 [200]	1	√	√
573431286	141 [286]	1	√	√

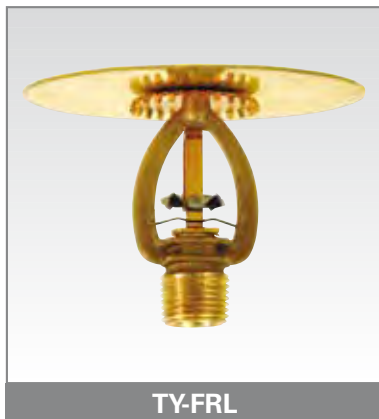

TFP 355

0.120 kg

Art. No. 560001849, W-Type 9
[P.1.117]

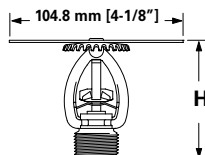

K=80 [5.6] • 1/2" NPT • SINTY3123 • H=69.9 mm [2-3/4"]

Art. No.	T °C [°F]	F	FM	UL
589861165	74 [165]	1	√	√

K=115 [8.0] • 3/4" NPT • SINTY4123 • H=71.4 mm [2-13/16"]

Art. No.	T °C [°F]	F	FM	UL
581531165	74 [165]	1	√	√

TYCERTFP 03/07 Tyco reserves the right to change the contents without notice

Storage Sprinklers, Intermediate Level, Shield for Pendent Sprinklers

RU Спринклеры для складских помещений, промежуточный уровень, щиток для спринклеров с плоской розеткой

TR Depo sprinklerler, ara seviyeler için, aşağı bakan sprinklerlere uygun koruyucu plakalar



 TFP 351

 0.04 kg

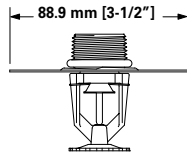

TY-B & TY-FRB

1/2" NPT

Art. No.	F	FM	UL
Shield+O-Ring Щиток+уплот. кольцо Plaka ve O halkası			
560709332	9	√	√

3/4" NPT

Art. No.	F	FM	UL
Shield+O-Ring Щиток+уплот. кольцо Plaka ve O halkası			
560709342	9	√	√

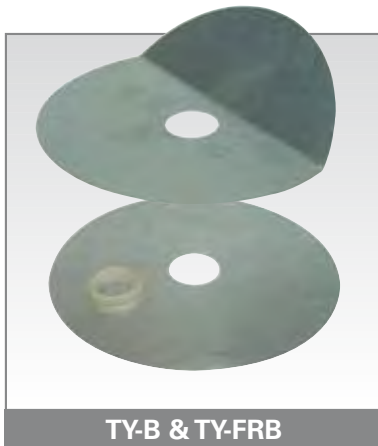

 0.15 kg

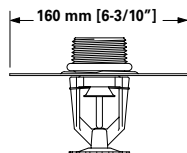

TY-B & TY-FRB

3/8" BSP • 1/2" NPT • 3/4" NPT

Art. No.	Art. No.	F
Shield Щиток Shield	O-Ring Уплотнительное кольцо O halkası	
2856160271	02141326	9

3/8" BSP • 1/2" NPT • 3/4" NPT

Art. No.	Art. No.	F
Shield 45° Щиток 45° Shield 45°	O-Ring Уплотнительное кольцо O halkası	
2856160272	02141326	9

TYCERTFP 03/07 Tyco reserves the right to change the contents without notice

Storage Sprinklers, Intermediate Level, Shield for Pendent Sprinklers

RU Спринклеры для складских помещений, промежуточный уровень, щиток для спринклеров с плоской розеткой

TR Depo sprinklerler, ara seviyeler için, aşağı bakan sprinklere uygun koruyucu plakalar

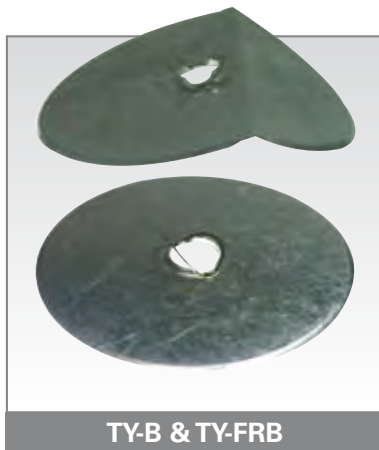

0.04 kg

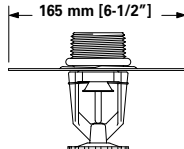

TY-B & TY-FRB

Standard			
Art. No. Shield Щиток Plaka	Size Диаметр Вой "	F	VDS
205-138	3/8	9	✓
205-112	1/2	9	✓
205-134	3/4	9	✓

45° Bended		Изгиб 45°/ 45° eğilimli/	
Art. No. Shield 45° Щиток 45° Plaka 45°	Size Диаметр Вой "	F	VDS
205-238	3/8	9	✓
205-212	1/2	9	✓
205-234	3/4	9	✓

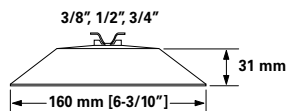
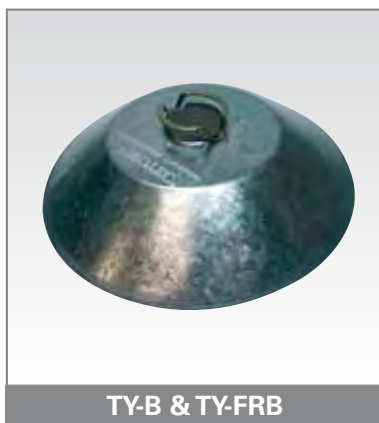

TY-B & TY-FRB

Standard			
Art. No. Shield 45° Щиток 45° Plaka 45°	Size Диаметр Вой "	F	VDS
205-338	3/8	9	✓
205-312	1/2	9	✓
205-334	3/4	9	✓

Storage Sprinklers, Intermediate Level, Shield for Pendent Sprinklers

RU Спринклеры для складских помещений, промежуточный уровень, щиток для спринклеров с плоской розеткой

TR Depo sprinklerler, ara seviyeler için, aşağı bakan sprinklere uygun koruyucu plakalar



TFP 350/355 [TY-FRL]



0.04 kg

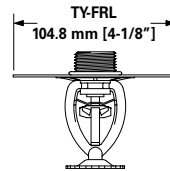
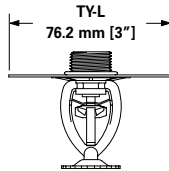

TY-L • 1/2" NPT			
Art. No. Shield+O-Ring Щиток+уплот. кольцо Plaka ve O halkası	F	FM*	UL*
560156802	1	√	√

TY-L • 3/4" NPT			
Art. No. Shield+O-Ring Щиток+уплот. кольцо Plaka ve O halkası	F	FM*	UL*
560156803	1	√	√

TY-FRL • 1/2" NPT			
Art. No. Shield+O-Ring Щиток+уплот. кольцо Plaka ve O halkası	F	FM*	UL*
569521001	1	√	√

TY-FRL • 3/4" NPT			
Art. No. Shield+O-Ring Щиток+уплот. кольцо Plaka ve O halkası	F	FM*	UL*
561521001	1	√	√

*Approval valid in combination with sprinkler model

*Сертификация действительна при сочетании с моделью спринклера

*Onay sprinkler modeline göre geçerlidir

Residential Sprinklers

RU Спринклеры для жилых помещений

TR Konut Tipi sprinklerler



LFII

Quick Response, [Recessed] Pendent

Быстрое реагирование, [утопленные] с плоской розеткой
Hızlı tepkili, [gömme] aşağı bakan

P. 1.054



LFII

Quick Response, [Recessed] Horizontal Sidewall [K=60&80]

Быстрое реагирование, [утопленные] горизонтальные настенные [K=60&80]
Hızlı tepkili, [gömme] yatay duvar tipi [K=60&80]

P. 1.055



LFII

Quick Response, Flush Pendent

Быстрого реагирования, плоское орошение
Hızlı tepkili, flush, aşağı bakan

P. 1.056



LFII

Quick Response, Flush Horizontal Sidewall

Быстрое реагирование, горизонтальное положение для настенного орошения
Hızlı tepkili, flush, yatay duvar tipi

P. 1.056



LFII

Quick Response, Pendent Concealed

Быстрого реагирования, с плоской розеткой, скрытые
Hızlı tepkili, aşağı bakan, gizli

P. 1.057



LFII

Domed Plate, Pendent Concealed

Купол, скрытые с плоской розеткой
Kubbe biçimli, aşağı bakan, gizli

P. 1.057

Residential Sprinklers, Quick Response, [Recessed] Pendent

RU Спринклеры для жилых помещений, быстрого реагирования, [утопленные] с плоской розеткой

TR Konut Tipi sprinklerler, hızlı tepkili, [gömme] aşağı bakan



TFP 400 / TFP 408 [K=100]



0.150 kg



[P.1.117]

Art. No. 560006387, W-Type 6
568504001, W-Type 7



[P.1.107]

Style 20 / style 30 [K=100]

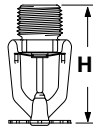

K=70 [4.9] • 1/2" NPT • SINTY2234 • H=57.2 mm [2-1/4"]

Art. No.	T °C [°F]	F	UL
512011155	68 [155]	1	√
512011175	79 [175]	1	√
512013155	68 [155]	3	√
512013175	79 [175]	3	√
512019155	68 [155]	9	√
512019175	79 [175]	9	√

K=100 [6.9] • 3/4" NPT • SINTY4234 • H=57.2 mm [2-1/4"]

Art. No.	T °C [°F]	F	UL
510681155	68 [155]	1	√
510681175	79 [175]	1	√
510683155	68 [155]	3	√
510683175	79 [175]	3	√
510689155	68 [155]	9	√
510689175	79 [175]	9	√

Residential Sprinklers, Quick Response, [Recessed] Horizontal Sidewall

RU Спринклеры для жилых помещений, быстрого реагирования, [утопленные] горизонтальные настенные

TR Konut Tipi sprinklerler, hızlı tepkili, [gömme] yatay duvar tipi



LFI



TFP 410 [K=60] TFP 415 [K=80]



0.150 kg



Art. No. 568504001, W-Type 7
568504001, W-Type 6

[P.1.117]



Style 20

[P.1.107]

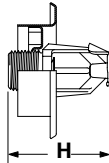

K=60 [4.2] • 1/2" NPT • SINTY1334 • H=57.2 mm [2-1/4"]

Art. No.	T °C [°F]	F	UL
512111155	68 [155]	1	√
512111175	79 [175]	1	√
512113155	68 [155]	3	√
512113175	79 [175]	3	√
512119155	68 [155]	9	√
512119175	79 [175]	9	√

K=80 [5.6] • 1/2" NPT • SINTY3334 • H=57.2 mm [2-1/4"]

Art. No.	T °C [°F]	F	UL
515241155	68 [155]	1	√
515241175	79 [175]	1	√
515243155	68 [155]	3	√
515243175	79 [175]	3	√
515249155	68 [155]	9	√
515249175	79 [175]	9	√

Residential Sprinklers, Quick Response, Flush Pendent

RU Спринклеры для жилых помещений, быстрого реагирования, плоское орошение

TR Konut Tipi sprinklerler, hızlı tepkili, flush, aşağı bakan



LFII

 TFP 420

 0.150 kg

 Art. No. 560004948
[P.1.117]

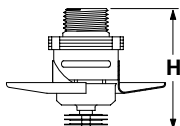

K=60[4.2] • 1/2" NPT • SINTY2284 • H=57.2 mm [2-1/4"]

Art. No. Sprinkler Спринклер Sprinkler	T °C [°F]	F	UL
511230162	72 [162]	9	√
511234162	72 [162]	4	√

K=60[4.2] • 1/2" NPT • SINTY2284 • H=57.2 mm [2-1/4"]

Art. No. Escutcheon Подрозетник Rozet	T °C [°F]	F	UL
561234001	72 [162]	4	√
561239001	72 [162]	9	√

Residential Sprinklers, Quick Response, Flush Horizontal Side Wall

RU Спринклеры для жилых помещений, быстрого реагирования, горизонтальное положение для настенного орошения

TR Konut Tipi sprinklerler, hızlı tepkili, flush, yatay duvar tipi

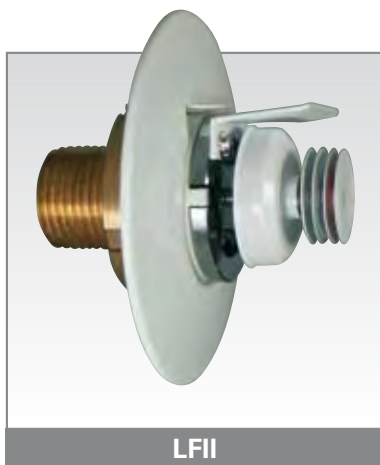

LFII

 TFP 425

 0.100 kg

 Art. No. 560004948
[P.1.117]

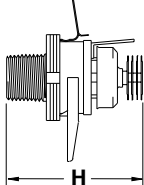

K=60[4.2] • 1/2" NPT • SINTY2384 • H=61.9 mm [2-7/16"]

Art. No. Sprinkler Спринклер Sprinkler	T °C [°F]	F	UL
511244162	72 [162]	4	√
511249162	72 [162]	9	√

K=60[4.2] • 1/2" NPT • SINTY2284 • H=57.2 mm [2-1/4"]

Art. No. Escutcheon Подрозетник Rozet	T °C [°F]	F	UL
561244001	72 [162]	4	√
561249001	72 [162]	9	√

TYCERTFP 03/07 Tyco reserves the right to change the contents without notice

Residential Sprinklers, Quick Response, Pendent Concealed

RU Спринклеры для жилых помещений, быстрого реагирования, скрытые, с плоской розеткой

TR Konut Tipi sprinklerler, hızlı tepkili, aşağı bakan, gizli



TFP 440 / TFP 420 [K=71]



0.240 kg



Art. No. 560001265, W-Type 18

[P.1.117]

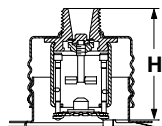

K=60[4.2] • 1/2" NPT • SIN TY2596 • H=47.6 mm ±3.2 [1-7/8±1/8"]

Art. No.	T °C [°F]	F	≡
511223160	71 [160]	3	√
511224160	71 [160]	4	√
511229160	71 [160]	9	√

K=71[4.9] • 1/2" NPT • SIN TY3596 • H=47.6 mm ±3.2 [1-7/8±1/8"]

Art. No.	T °C [°F]	F	≡
511123160	71 [160]	3	√
511124160	71 [160]	4	√
511129160	71 [160]	9	√

Residential Sprinklers, Domed Plate, Pendent Concealed

RU Спринклеры для жилых помещений, купол, скрытые, с плоской розеткой

TR Konut Tipi sprinklerler, kubbe biçimli, hızlı tepkili, aşağı bakan, gizli



TFP 450 / TFP 408 [K=100]



0.240 kg



Art. No. 568504001

[P.1.117]

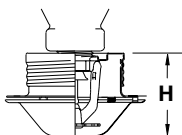

K=70[4.9] • 1/2" NPT • SIN TY2234 • H=54.0 mm ±6.4 [2.2/16±1/4"]

Art. No.	T °C [°F]	F	≡
518733155	68 [155]	3	√
518734155	68 [155]	4	√
518739155	68 [155]	9	√









K=100[6.9] • 3/4" NPT • SIN TY4234 • H=54.0 mm ±6.4 [2.2/16±1/4"]

Art. No.	T °C [°F]	F	≡
510683155	68 [155]	3	√
510684155	68 [155]	4	√
510689155	68 [155]	9	√

TYCERTFP 03/07 Tyco reserves the right to change the contents without notice

Dry Sprinklers

- RU** Спринклеры сухого типа
TR Kuru borulu (soguk odalar icin) sprinklerler

 DS-1	Standard Coverage, Pendent Со стандартной зоной орошения, с плоской розеткой Normal kaplama alanlı, aşağı bakan	P. 1.059
 DS-SS316	Standard Coverage, Pendent, Stainless Steel Со стандартной зоной орошения, с плоской розеткой, нержавеющая сталь Normal kaplama alanlı, aşağı bakan, paslanmaz çelik	P. 1.060
 HTS-15	Standard Coverage, Pendent Со стандартной зоной орошения, с плоской розеткой Normal kaplama alanlı, aşağı bakan	P. 1.061
 DS-1	Standard Coverage, Upright Со стандартной зоной орошения, с вогнутой розеткой Normal kaplama alanlı, yukarı bakan	P. 1.062
 DS-1	Standard Coverage, Horizontal Sidewall Со стандартной зоной орошения, горизонтальные настенные Normal kaplama alanlı, yatay duvar tipi	P. 1.063
 DS-2	Standard Coverage, Pendent Со стандартной зоной орошения, с плоской розеткой Normal kaplama alanlı, aşağı bakan	P. 1.064
 DS-2	Extended Coverage, Pendent С расширенной зоной орошения, с плоской розеткой Normal kaplama alanlı, aşağı bakan	P. 1.065
 DS-ECC	Quick Response, Extended Coverage, Pendent Consealed Быстро реагирующая, с расширенной зоной орошения, с плоской розеткой, скрытые Hızlı tepkili, genişletilmiş kaplama alanlı, aşağı bakan, gizli	P. 1.066

Dry Sprinklers, Standard Coverage, Pendent

RU Спринклеры сухого типа, со стандартной зоной орошения, с плоской розеткой

TR Kuru borulu sprinklerler, normal kaplama alanlı, aşağı bakan



TFP 500/510 [Quick Response/ Быстрое реагирование/ Hızlı tepkili]



Art. No. 568504001, W-Type 7

[P.1.117]

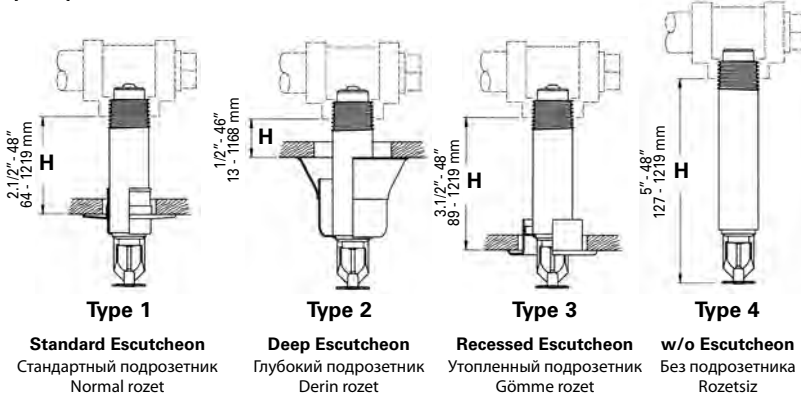

K=80 [5.6] • 1" ISO • SINTY3255 • UL/FM/CNBOP • CE

ART. NR. I60 XX X X XXX

Standard Response/ Стандартное реагирование/ Normal tepkili		Temp. °C [°F]		Sprinkler/ Спринклер/ Sprinkler		F	Escutcheon/ Подрозетник/ Rozet		H* mm ["]	
96	Type 1	0	57 [135]	1	Brass/Латунь/Pirinç		White/Белый/Beyaz	060	152 [6.00]	
93	Type 2	1	68 [155]	4	White/Белый/Beyaz		White/Белый/Beyaz	062	159 [6.25]	
97	Type 3	2	79 [175]	9	Chrome/Хром/Krom		Chrome/Хром/Krom	065	165 [6.50]	
92	Type 4	3	93 [200]	0	Chrome/Хром/Krom		White/Белый/Beyaz	067	171 [6.75]	
		4	141 [286]**					372	946 [37.25]	
		5	182 [360]**					480	1219 [48.00]	

****Not available for type 3??**

** Нет для типа 3

** Tip 3 için bulunmamaktadır

*** Available in Pendent, Upright and Conventional**

* Есть с плоской розеткой, вогнутой розеткой и стандартные

* Aşağı bakan, yukarı bakan ve konvansiyonel olarak bulunur

K=80 [5.6] • 1" ISO • SINTY3235 • UL/FM

ART. NR. I60 XX X X XXX

Quick Response/ Быстрое реагирование/ Hızlı tepkili		Temp. °C [°F]		Sprinkler/ Спринклер/ Sprinkler		F	Escutcheon/ Подрозетник/ Rozet		H* mm ["]	
36	Type 1	0	57 [135]	1	Brass/Латунь/Pirinç		White/Белый/Beyaz	060	152 [6.00]	
33	Type 2	1	68 [155]	4	White/Белый/Beyaz		White/Белый/Beyaz	062	159 [6.25]	
37	Type 3	2	79 [175]	9	Chrome/Хром/Krom		Chrome/Хром/Krom	065	165 [6.50]	
32	Type 4	3	93 [200]	0	Chrome/Хром/Krom		White/Белый/Beyaz	067	171 [6.75]	
		4	141 [286]					372	946 [37.25]	
		5	182 [360]					480	1219 [48.00]	

***Order length in 6 mm [1/4"] increments**

*Заказываемая длина с приращением по 6 мм [1/4"]

*6 mm [1/4"] aralıklarla siparişinizi verebilirsiniz

TYCERTFP 03/07 Tyco reserves the right to change the contents without notice

Dry Sprinklers, Standard Coverage, Pendent

RU Спринклеры сухого типа, со стандартной зоной орошения, с плоской розеткой

TR Kuru borulu sprinklerler, normal kaplama alanlı, aşağı bakan

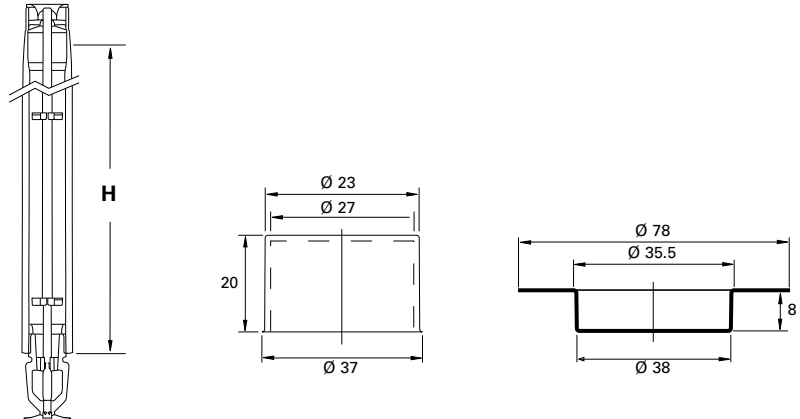

K=80 [5.6] • 1" ISO

ART. NR. A531 X X X XXX

Escutcheon/ Подрозетник/ Rozet			Connection/ Соединение/ Bağlantı			Temperature/ Температура/ Isı/			Length mm/ Длина, мм/ Uzunluk mm/	
A	No escutcheon	Без подрозетника Rozetsiz	M	SS316 unthreaded end 18 mm/ SS316 - конец без резьбы, 18 mm/ SS316 yivsiz uç 18 mm	A	57° C	050	Min.	Мин.	Asgari
B	With 2-piece escutcheon SS304 С подрозетником из 2 деталей, SS304 Çift rozetli, SS304		R	SS316 unthreaded end 10 mm/ SS316 - конец без резьбы, 10 mm/ SS316 yivsiz uç 10 mm	B	68° C	999	Max.	Макс.	Azami
					D	79° C				
					E	93° C				
					G	141° C				
					C	182° C				

Dry Sprinklers, Standard Coverage, Pendent

RU Спринклеры сухого типа, со стандартной зоной орошения, с плоской розеткой

TR Kuru borulu sprinklerler, normal kaplama alanlı, aşağı bakan



Art. No. 568504001, W-Type 7

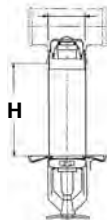

K=80 [5.6] • 1" ISO

Art. No. Standard Стандартный Normal	T °C [°F]	F	H mm	VDS	PAVUS	T/S/U
GHTSFB5100	68 [155]	9	100	√	√	√
GHTSFB5200	68 [155]	9	200	√	√	√
GHTSFB5300	68 [155]	9	300	√	√	√
GHTSFB5400	68 [155]	9	400	√	√	√
GHTSFB5500	68 [155]	9	500	√	√	√



Art. No.

Description

Описание
Tanımlama

2145386 White Escutcheon HTS15 Белый подрозетник HTS15 Beyaz rozet HTS15

Dry Sprinklers, Standard Coverage, Upright

RU Спринклеры сухого типа, со стандартной зоной орошения, с вогнутой розеткой

TR Kuru borulu sprinklerler, normal kaplama alanlı, yukarı bakan



TFP 500/510 Quick Response/
Быстрое реагирование/
Hızlı tepkili



Art. No. 568504001, W-Type 7

[P.1.117]

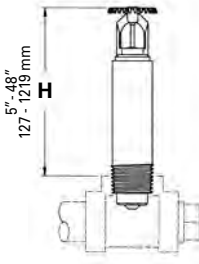

K=80 [5.6] • 1" ISO • SINTY3155 • UL/FM • CE

ART. NR. I60 XX X X XXX

98	Standard Response/ Стандартное реагирование/ Normal tepkili	Temp. °C [°F]		Sprinkler/ Спринклер/ Sprinkler	F	Escutcheon/ Подрозетник/ Rozet	H*	
		°C	[°F]				mm	["]
Upright/С вогнутой розеткой/Уkarı bakan	0	57	[135]	1	Brass/Латунь/Pirinç	White/Белый/Beıaz	060	152 [6.00]
	1	68	[155]	4	White/Белый/Beıaz	White/Белый/Beıaz	062	159 [6.25]
	2	79	[175]	9	Chrome/Хром/Кром	Chrome/Хром/Кром	065	165 [6.50]
	3	93	[200]	0	Chrome/Хром/Кром	White/Белый/Beıaz	067	171 [6.75]
	4	141	[286]				372	946 [37.25]
	5	182	[360]				480	1219 [48.00]

K=80 [5.6] • 1" ISO • SINTY3135 • UL/FM

ART. NR. I60 XX X X XXX

38	Quick Response/ Быстрое реагирование/ Hızlı tepkili	Temp. °C [°F]		Sprinkler/ Спринклер/ Sprinkler	F	Escutcheon/ Подрозетник/ Rozet	H*	
		°C	[°F]				mm	["]
Upright/С вогнутой розеткой/Уkarı bakan	0	57	[135]	1	Brass/Латунь/Pirinç	White/Белый/Beıaz	060	152 [6.00]
	1	68	[155]	4	White/Белый/Beıaz	White/Белый/Beıaz	062	159 [6.25]
	2	79	[175]	9	Chrome/Хром/Кром	Chrome/Хром/Кром	065	165 [6.50]
	3	93	[200]	0	Chrome/Хром/Кром	White/Белый/Beıaz	067	171 [6.75]
	4	141	[286]				372	946 [37.25]
	5	182	[360]				480	1219 [48.00]

*Order length in 6 mm [1/4"] increments

*Заказываемая длина с приращением по 6 mm [1/4"]

*6 mm [1/4"] aralıklarla siparişinizi verebilirsiniz

TYCER TFP 03/07 Tyco reserves the right to change the contents without notice

RU Спринклеры сухого типа, со стандартной зоной орошения, горизонтальные настенные

TR Kuru borulu sprinklerler, normal kaplama alanlı, yatay duvar tipi



TFP 500/510 Quick Response/
Быстрое реагирование/
Hızlı tepkili



Art. No. 568504001, W-Type 7

[P.1.117]

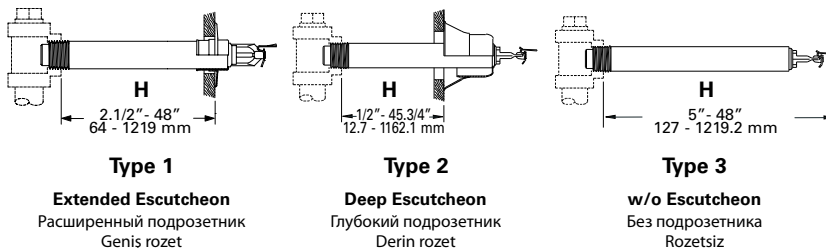

K=80 [5.6] • 1" ISO • SINTY3355 • UL/FM • CE

ART. NR. I60 XX X X XXX

	Standard Response/ Стандартное реагирование/ Normal tepkili	Temp. °C [°F]		Sprinkler/ Спринклер/ Sprinkler		Escutcheon/ Подрозетник/ Rozet		H* mm ["]	
		F							
94	Horizontal Sidewall Type 1/ Горизонтальный настенный, тип 1/ Yatay duvar tipi 1	0	57 [135]	1	Brass/Латунь/Pirinç	White/Белый/Beyaz	060	152 [6.00]	
53	Horizontal Sidewall Type 2/ Горизонтальный настенный, тип 2/ Yatay duvar tipi 2	1	68 [155]	4	White/Белый/Beyaz	White/Белый/Beyaz	062	159 [6.25]	
		2	79 [175]	9	Chrome/Хром/Krom	Chrome/Хром/Krom	065	165 [6.50]	
		3	93 [200]	0	Chrome/Хром/Krom	White/Белый/Beyaz	067	171 [6.75]	
54	Horizontal Sidewall Type 3/ Горизонтальный настенный, тип 3/ Yatay duvar tipi 3	4	141 [286]				372	946 [37.25]	
		5	182 [360]				480	1219 [48.00]	

K=80 [5.6] • 1" ISO • SINTY3335 • UL/FM

ART. NR. I60 XX X X XXX

	Quick Response/ Быстрое реагирование/ Hızlı tepkili	Temp. °C [°F]		Sprinkler/ Спринклер/ Sprinkler		Escutcheon/ Подрозетник/ Rozet		H* mm ["]	
		F							
34	Horizontal Sidewall Type 1/ Горизонтальный настенный, тип 1/ Yatay duvar tipi 1	0	57 [135]	1	Brass/Латунь/Pirinç	White/Белый/Beyaz	060	152 [6.00]	
43	Horizontal Sidewall Type 2/ Горизонтальный настенный, тип 2/ Yatay duvar tipi 2	1	68 [155]	4	White/Белый/Beyaz	White/Белый/Beyaz	062	159 [6.25]	
		2	79 [175]	9	Chrome/Хром/Krom	Chrome/Хром/Krom	065	165 [6.50]	
		3	93 [200]	0	Chrome/Хром/Krom	White/Белый/Beyaz	067	171 [6.75]	
44	Horizontal Sidewall Type 3/ Горизонтальный настенный, тип 3/ Yatay duvar tipi 3	4	141 [286]				372	946 [37.25]	
		5	182 [360]				480	1219 [48.00]	

*Order length in 6 mm [1/4"] increments

*Заказываемая длина с приращением по 6 мм [1/4"]

*6 mm [1/4"] aralıklarla siparişinizi verebilirsiniz

Dry Sprinklers, Standard Coverage, Pendent

RU Спринклеры сухого типа, со стандартной зоной орошения, с плоской розеткой

TR Kuru borulu sprinklerler, normal kaplama alanlı, aşağı bakan



TFP 530

Art. No. 568504001, W-Type 7
[P.1.117]

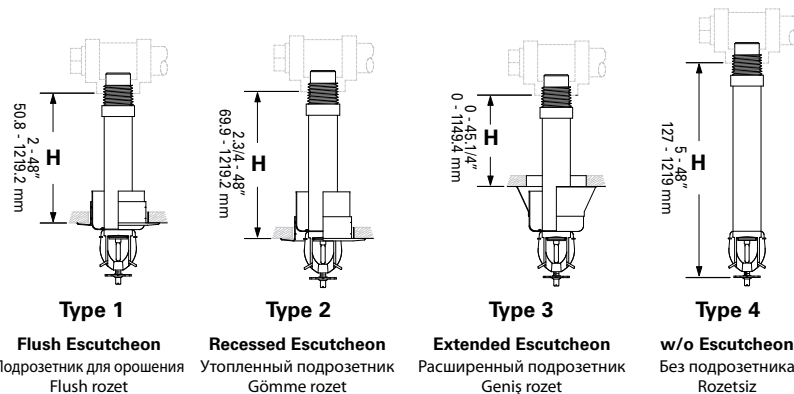

K=147-161 [10.2-11.2] • 1" ISO • SINTY5255 • UL

ART. NR. I 61 XX X X XXX

Standard Response/ Стандартное реагирование/ Normal tepkili		Temp. °C [°F]		Sprinkler/ Спринклер/ Sprinkler		F Escutcheon/ Подрозетник/ Rozet		H* mm ["]	
10	Type 1	0	57 [135]	1	Brass/Латунь/Pirinç	White/Белый/Beyaz	060	152 [6.00]	
11	Type 2	1	68 [155]	4	White/Белый/Beyaz	White/Белый/Beyaz	062	159 [6.25]	
12	Type 3	2	79 [175]	9	Chrome/Хром/Krom	Chrome/Хром/Krom	065	165 [6.50]	
13	Type 4	3	93 [200]	0	Chrome/Хром/Krom	White/Белый/Beyaz	067	171 [6.75]	
		4	141 [286]	5	Brass/Латунь/Pirinç	Brass/Латунь/Pirinç	372	946 [37.25]	
							480	1219 [48.00]	

K=147-161 [10.2-11.2] • 1" ISO • SINTY5235 • UL/FM

ART. NR. I 61 XX X X XXX

Quick Response/ Быстрое реагирование/ Hızlı tepkili/		Temp. °C [°F]		Sprinkler/ Спринклер/ Sprinkler		F Escutcheon/ Подрозетник/ Rozet		H* mm ["]	
30	Type 1	0	57 [135]	1	Brass/Латунь/Pirinç	White/Белый/Beyaz	060	152 [6.00]	
31	Type 2	1	68 [155]	4	White/Белый/Beyaz	White/Белый/Beyaz	062	159 [6.25]	
32	Type 3	2	79 [175]	9	Chrome/Хром/Krom	Chrome/Хром/Krom	065	165 [6.50]	
35	Type 4	3	93 [200]	0	Chrome/Хром/Krom	White/Белый/Beyaz	067	171 [6.75]	
		4	141 [286]	5	Brass/Латунь/Pirinç	Brass/Латунь/Pirinç	372	946 [37.25]	
							480	1219 [48.00]	

*Order length in 6 mm [1/4"] increments

*Заказываемая длина с приращением по 6 мм [1/4"]

*6 mm [1/4"] aralıklarla siparişinizi verebilirsiniz

TYCERTFP 03/07 Tyco reserves the right to change the contents without notice

Dry Sprinklers, Extended Coverage, Pendent

RU Спринклеры сухого типа, с расширенной зоной орошения, с плоской розеткой

TR Kuru borulu sprinklerler, genişletilmiş kaplama alanlı, aşağı bakan



TFP540



Art. No. 568504001, W-Type 7

[P.1.117]

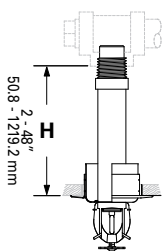

Type 1

Flush Escutcheon
Подрозетник для орошения
Flush rozet

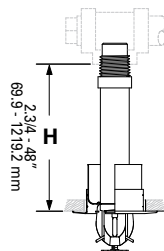

Type 2

Recessed Escutcheon
Утопленный подрозетник
Gömme rozet

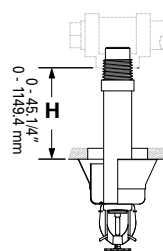

Type 3

Extended Escutcheon
Расширенный подрозетник
Geniş rozet

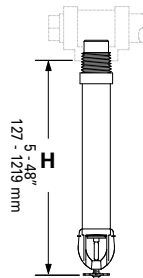

Type 4

w/o Escutcheon
Без подрозетника
Rozetsiz

K=147-161 [10.2-11.2] • 1" ISO • SINTY5238 • UL

ART. NR. 161 XX X X XXX

Standard & Quick Response/ Стандартное и быстрое реагирование/ Normal ve hızlı tepkili		Temp. °C [°F]		Sprinkler/ Спринклер/ Sprinkler		F Escutcheon/ Подрозетник/ Rozet		H* mm ["]	
40	Type 1	0	57 [135]	1	Brass/Латунь/Pirinç	White/Белый/Beyaz	060	152 [6.00]	
41	Type 2	1	68 [155]	4	White/Белый/Beyaz	White/Белый/Beyaz	062	159 [6.25]	
42	Type 3	2	79 [175]	9	Chrome/Хром/Krom	Chrome/Хром/Krom	065	165 [6.50]	
43	Type 4	3	93 [200]	0	Chrome/Хром/Krom	White/Белый/Beyaz	067	171 [6.75]	
		4	141 [286]	5	Brass/Латунь/Pirinç	Brass/Латунь/Pirinç	372	946 [37.25]	
							480	1219 [48.00]	

*Order length in 6 mm [1/4"] increments

*Заказываемая длина с приращением по 6 mm [1/4"]

*6 mm [1/4"] aralıklarla siparişinizi verebilirsiniz

Dry Sprinklers, Quick Response, Extended Coverage, Pendent Consealed

RU Спринклеры сухого типа, быстрого реагирования, с расширенной зоной орошения, с плоской розеткой, скрытые

TR Kuru borulu sprinklerler, hızlı tepkili, genişletilmiş kaplama alanlı, aşağı bakan, gizli



 TFP 518

 Art. No. 560001075, RFI Wrench

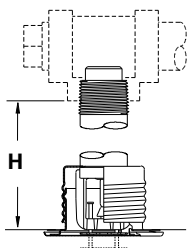

K=80 [5.6] • 1" ISO • SINTY3539 • UL		ART. NR. I 60		XX	X	1	XXX
45	Quick Response/Быстрое реагирование/ Hızlı tepkili	Temp. °C [°F]		H*			
	Pendent /С плоской розеткой /Аşağı bakan	1	68 [155]	055	140 [5.50]		
		3	93 [200]	082	210 [8.25]		
				180	457 [18.00]		
				187	476 [18.75]		
				372	946 [37.25]		
				480	1219 [48.00]		

Cover Plate /Плоская крышка /Karak		
Art. No.	T °C [°F]	F
567921135	57 [135]	1
567923135	57 [135]	3
677929135	57 [135]	9
567921165	74 [165]	1
567923165	74 [165]	3
567929165	74 [165]	9

RU Спринклеры специального назначения и многоструйные оросители

TR Özel sprinklerler ve kontrol sprinklerler



**BB1- & BB2-
& BB3-17/32**

Quick Response, Attic

Быстрого реагирования, чердачные
Hızlı tepkili, tavanarası

P. 1.069



**BB1- & BB2-
& BB3-1/2"**

Quick Response, Attic

Быстрого реагирования, чердачные
Hızlı tepkili, tavanarası

P. 1.069



**SD1- & SD2-
& SD3-1/2"**

Quick Response, Attic

Быстрого реагирования, чердачные
Hızlı tepkili, tavanarası

P. 1.070



HIP

Quick Response, Attic

Быстрого реагирования, чердачные
Hızlı tepkili, tavanarası

P. 1.070

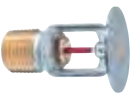

WS

Quick Response, Horizontal Sidewall, Window

Быстрое реагирование, горизонтальные настенные, оконные
Hızlı tepkili, yatay duvar tipi, pencere

P. 1.071



WS

Quick Response, Upright, Window

Быстрого реагирования, с вогнутой розеткой, оконные
Hızlı tepkili, yukarı bakan, pencere

P. 1.071



CC1 & CC2

Quick Response, Upright, Combustible Concealed

Быстрого реагирования, с вогнутой розеткой, оконные, скрытые от огня
Hızlı tepkili, yukarı bakan, kolay tutuşan ara tavanlar için

P. 1.072



TFP-PH5

Institutional, Pendent

Для учреждений, с плоской розеткой
Kurumsal, aşağı bakan

P. 1.073



TFP-MAX

Institutional, Pendent

Для учреждений, с плоской розеткой
Kurumsal, aşağı bakan

P. 1.073



TFP-PH2

Institutional, Horizontal Sidewall

Для учреждений, горизонтальные настенные
Kurumsal, yatay duvar tipi

P. 1.074



TFP-MAX









Institutional, Horizontal Sidewall

Для учреждений, горизонтальные настенные
Kurumsal, yatay duvar tipi

P. 1.074

RU Спринклеры специального назначения и многоструйные оросители

TR Özel sprinklerler ve kontrol sprinklerler

	High Temperature, Pendent Высокотемпературные, с плоской розеткой Yüksek ısı, aşağı bakan	P. 1.075
ISSUE D		
	High Temperature, Upright Высокотемпературные, с вогнутой розеткой Yüksek ısı, yukarı bakan	P. 1.076
ISSUE D		
	Flat Spray, Pendent Плоского орошения, с плоской розеткой Yatay, yassi sprej, aşağı bakan	P. 1.077
TY-FS		
	Flat Spray, Upright Плоского орошения, с вогнутой розеткой Yatay, yassi sprej, yukarı bakan	P. 1.078
TY-FS		
	Safety Twin Sprinkler Защитный сдвоенный спринклер Çift baslikli emniyet sprinkleri	P. 1.079
DS-21		
	Special Materials Специальные материалы Özel ürünler	P. 1.080
TY-B & TY-FRB		
	Multiple Jet Controls, Single Inlet, Single Outlet Многоструйные оросители, одиночное входное отверстие, одиночное выходное отверстие Kontrol sprinklerleri 1 giriş, 1 çıkış	P. 1.081
MJCS		
	Multiple Jet Controls Single Inlet, Double Outlet Многоструйные оросители, одиночное входное отверстие, двойное выходное отверстие Kontrol sprinklerleri 1 giriş, 2 çıkış	P. 1.082
MJCD		
	Multiple Jet Controls, Double Inlet, Single Outlet Многоструйные оросители, двойное входное отверстие, одиночное выходное отверстие Kontrol sprinklerleri 2 giriş, 1 çıkış	P. 1.083
MJC		

RU Специальные спринклеры, быстрое реагирование, чердачные

TR Özel sprinklerler, hızlı tepkili, tavanarası



TFP 610



0.100 kg



[P.1.117]

Art. No. 568951001, W-Type 3

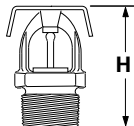

BB1- & BB2- & BB3-17/32

K=115 [8.0] • 3/4" NPT • H=54.0 mm [2-1/8"]

Art. No.	SIN	Type	Pitch	T	F	UL
				°C [°F]		
516231200	TY4180	BB1	4/12	93 [200]	1	√
516211200	TY4181	BB2	8/12	93 [200]	1	√
516221200	TY4182	BB3	12/12	93 [200]	1	√



TFP 610



0.100 kg



[P.1.117]

Art. No. 568951001, W-Type 3

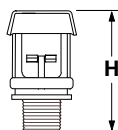

BB1- & BB2- & BB3-1/2

K=80 [5.6] • 1/2" NPT • H=63.5 mm [2-1/2"]

Art. No.	SIN	Type	Pitch	T	F	UL
				°C [°F]		
506011212	TY3180	BB1	4/12	100 [212]	1	√
506021212	TY3181	BB2	8/12	100 [212]	1	√
506031212	TY3182	BB3	12/12	100 [212]	1	√

Special Sprinklers, Quick Response, Attic

RU Специальные спринклеры, быстрое реагирование, чердачные

TR Özel sprinklerler, hızlı tepkili, tavanarası



SD1- & SD2- & SD3-1/2



TFP 610



0.100 kg



[P.1.117]

Art. No. 568951001, W-Type 3

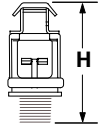

K=80 [5.6] • 1/2" NPT • H=76.2 mm [3"]

Art. No.	SIN	Type	Pitch	T °C [°F]	F	UL
506111212	TY3183	SD1	4/12	100 [212]	1	√
506121212	TY3184	SD2	8/12	100 [212]	1	√
506131212	TY3185	SD3	12/12	100 [212]	1	√



HIP



TFP 610



0.100 kg



[P.1.117]

Art. No. 568951001, W-Type 3

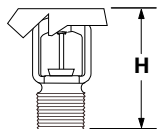

K=80 [5.6] • 1/2" NPT • H=50.8 mm [2"]

Art. No.	SIN	Type	T °C [°F]	F	UL
516201200	TY3187	HIP	93 [200]	1	√

RU Специальные спринклеры, быстрое реагирование, оконные

TR Özel sprinklerler, hızlı tepkili, pencere



WS



TFP 620



0.100 kg



[P.1.117]

Art. No. 1106

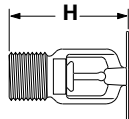

K=80 [5.6] • 1/2" NPT • SINTY3388 • H=54.0 mm [2-1/8"]

Art. No. Horizontal Горизонтальные Yataş	T °C [°F]	F	UL CNBOP
503051155	68 [155]	1	√ √
503051200	93 [200]	1	√ √
503054155	68 [155]	4	√ √
503054200	93 [200]	4	√ √
503059155	68 [155]	9	√ √
503059200	93 [200]	9	√ √



WS



TFP 620



0.100 kg



[P.1.117]

Art. No. 1106

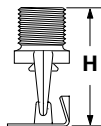

K=80 [5.6] • 1/2" NPT • SINTY3488 • H=54.0 mm [2-1/8"]

Art. No. Vertical Вертикальные Dikey	T °C [°F]	F	UL CNBOP
503041155	68 [155]	1	√ √
503041200	93 [200]	1	√ √
503044155	68 [155]	4	√ √
503044200	93 [200]	4	√ √
503049155	68 [155]	9	√ √
503049200	93 [200]	9	√ √

Special Sprinklers, Quick Response, Combustible Concealed

RU Специальные спринклеры, быстрое реагирование, скрытые от огня

TR Özel sprinklerler, hızlı tepkili, kolay tutuşan maddeler için, gizli



CC1



TFP 630



0.100 kg



[P.1.117]

Art. No. 560001106, W-Type 20

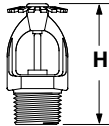

K=43 [3.0] • 1/2" NPT • SIN TY1189 • H=57.2 mm [2-1/4"]

Art. No.	T °C [°F]	F	UL
503001175	79 [175]	1	√



CC2



TFP 632



0.100 kg



[P.1.117]

Art. No. 560006387, W-Type 6

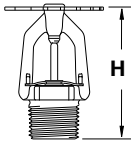

K=80 [5.6] • 1/2" NPT • SIN TY3189 • H=57.2 mm [2-1/4"]

Art. No.	T °C [°F]	F	UL
513011175	79 [175]	1	√

K=60 [4.2] • 1/2" NPT • SIN TY2189 • H=57.2 mm [2-1/4"]

Art. No.	T °C [°F]	F	UL
513111175	79 [175]	1	√

TYCERTFP 03/07 Tyco reserves the right to change the contents without notice

Special Sprinklers, Institutional Pendant

RU Специальные спринклеры, для учреждений, с плоской розеткой

TR Özel tepkili, kurumsal, aşağı bakan



TFP-PH5

TFP 650

0.08 kg

Art. No. 560015093
[P.1.117]

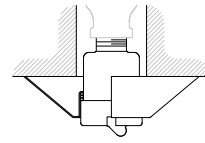
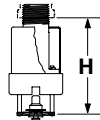

Type C
Escutcheon/
Подрозетник/
Rozet

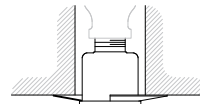

Type A
Escutcheon/
Подрозетник/
Rozet

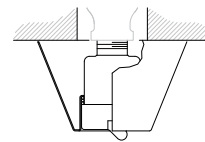

Type B-1
Escutcheon/
Подрозетник/
Rozet

K=80[5.6] • 1/2" NPT • SIN TY3290 • H=80.18 mm [3-1/8"]

Art. No. Standard Стандартный Normal	T °C [°F]	F	UL
511049140	60 [140]	9	✓
511049165	74 [165]	9	✓
511049212	100 [212]	9	✓

Escutcheon		/Подрозетник	/Rozet
Art. No.	Type	F	
560127622	A	9	
560017511	B-1	9	
560017513	C	9	



TFP-MAX

TFP 652

0.08 kg

Art. No. 560015093
[P.1.117]

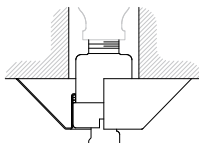

Type D
Escutcheon/
Подрозетник/
Rozet

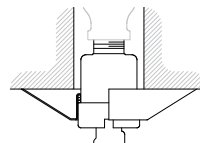

Type E
Escutcheon/
Подрозетник/
Rozet

K=80[5.6] • 1/2" NPT • SIN TY3291 • H=80.18 mm [3-1/8"]

Art. No. Quick Оперативность Hızlı	T °C [°F]	F	UL
511039135	57 [135]	9	✓
511039155	68 [155]	9	✓
511039175	79 [175]	9	✓
511039200	93 [200]	9	✓

Escutcheon		/Подрозетник	/Rozet
Art. No.	Type	F	
560017514	D	9	
560017515	E	9	

TYCERTFP 03/07 Tyco reserves the right to change the contents without notice

RU Специальные спринклеры, для учреждений, горизонтальные настенные

TR Özel tepkili, kurumsal, yatay duvar tipi



TFP-PH2

TFP 654

0.08 kg

Art. No. 560015093
[P.1.117]

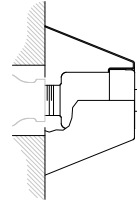
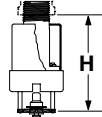

Type B-2
Escutcheon/
Подрозетник/
Rozet

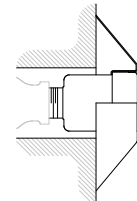

Type C
Escutcheon/
Подрозетник/
Rozet

K=80[5.6] • 1/2" NPT • SIN TY3390 • H=80.18 mm [3-1/8"]

Art. No. Стандартный Normal	T °C [°F]	F	≡
511069140	60 [140]	9	√

Art. No.	Type	F
560017512	B-2	9
560017513	C	9

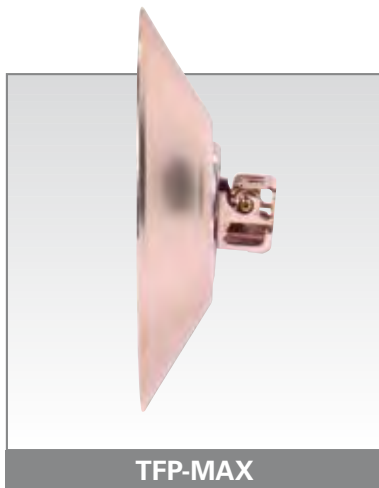

TFP-MAX

TFP 656

0.08 kg

Art. No. 560015093
[P.1.117]

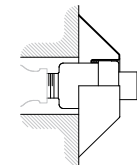

Type B1
Escutcheon/
Подрозетник/
Rozet

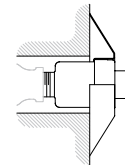

Type E
Escutcheon/
Подрозетник/
Rozet

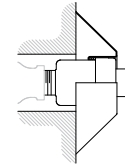

Type D
Escutcheon/
Подрозетник/
Rozet

K=80[5.6] • 1/2" NPT • SIN TY3391 • H=80.18 mm [3-1/8"]

Art. No. Quick Оперативность Hızlı	T °C [°F]	F	≡
511079135	57 [135]	9	√
511079165	68 [155]	9	√
511079212	79 [175]	9	√
511079200	93 [200]	9	√

Art. No.	Type	F
560017511	B1	9
560017514	D	9
560017515	E	9

RU Специальные спринклеры, высокотемпературные, серия Issue "D" Quartzoid®

TR Özel sprinklerler, yüksek ısı, "D" Quartzoid® serisi



 TD 525 M

 0.100 kg

 Art. No. 564521001, W-Type 11
[P.1.117]

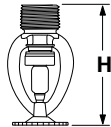



K=80 [5.6] • 1/2" NPT • SIN G1040 • H=74.6 mm [2-15/16"]

Art. No. Pendent С плоской розеткой Аşağı bakan	T °C [°F]	F	UL	FM	LPC
510401400	204 [400]	1	√	√	
510401500	260 [500]	1	√	√	√
510401650	343 [650]	1	√	√	
510409400	204 [400]	9	√	√	
510409500	260 [500]	9	√	√	
510409650	343 [650]	9	√	√	



 TD 527 Q

 0.100 kg

 Art. No. 564521001, W-Type 11
[P.1.117]

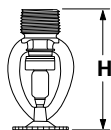

K=115 [8.0] • 3/4" NPT • SIN G1140 • H=74.6 mm [2-15/16"]

Art. No. Pendent С плоской розеткой Аşağı bakan	T °C [°F]	F	UL
511401400	204 [400]	1	√
511401500	260 [500]	1	√
511409400	204 [400]	9	√
511409500	260 [500]	9	√

RU Специальные спринклеры, высокотемпературные, серия Issue "D" Quartzoid®

TR Özel sprinklerler, yüksek ısı, "D" Quartzoid® serisi



 TD 525 M

 0.100 kg

 Art. No. 564521001, W-Type 11
[P.1.117]

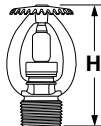



K=80 [5.6] • 1/2" NPT • SIN G1036 • H=74.6 mm [2-15/16"]

Art. No. Upright Свогнутой розеткой Yukarı bakan	T °C [°F]	F	LPB	FM	UL
510361400	204 [400]	1	√	√	√
510361500	260 [500]	1	√	√	√
510361650	343 [650]	1	√	√	√
510369400	204 [400]	9	√	√	√
510369500	260 [500]	9	√	√	√
510369650	343 [650]	9	√	√	√



 TD 527 Q

 0.100 kg

 Art. No. 564521001, W-Type 11
[P.1.117]

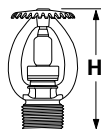

K=115 [8.0] • 3/4" NPT • SIN G1136 • H=74.6 mm [2-15/16"]

Art. No. Upright Свогнутой розеткой Yukarı bakan	T °C [°F]	F	UL
511361400	204 [400]	1	√
511361500	260 [500]	1	√
511369400	204 [400]	9	√
511369500	260 [500]	9	√

RU Специальные спринклеры плоского орошения

TR Özel tepkili, yatay, yassi sprej

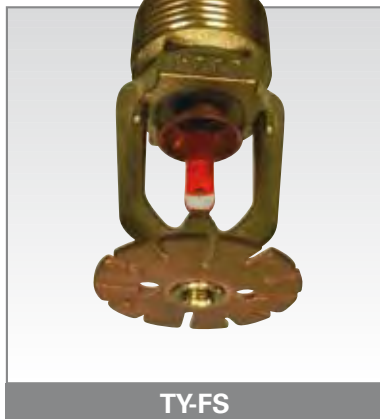

TFP635



0.100 kg



Art. No. 56006387, W-Type 6

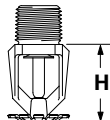

K=57 [4.0] • 3/8" ISO • H=40 mm						
Art. No. Pendent С плоской розеткой Аşağı bakan	T °C [°F]	F	Response Реагирование Терки	SIN	VDS	CE
513821135	57 [135]	1	Quick/Быстр. реар./Hızlı	TY1236	✓	✓
513821155	68 [155]	1	Quick/Быстр. реар./Hızlı	TY1236	✓	✓
513821200	93 [200]	1	Quick/Быстр. реар./Hızlı	TY1236	✓	✓
513821286	141 [286]	1	Special/Специальные/Özel	TY1236	✓	✓
514821135	57 [135]	1	Special/Специальные/Özel	TY1246	✓	✓
514821155	68 [155]	1	Special/Специальные/Özel	TY1246	✓	✓
514821200	93 [200]	1	Special/Специальные/Özel	TY1246	✓	✓
514821286	141 [286]	1	Special/Специальные/Özel	TY1246	✓	✓
515821135	57 [135]	1	Standard	TY1256	✓	✓
515821155	68 [155]	1	Standard	TY1256	✓	✓
515821200	93 [200]	1	Standard	TY1256	✓	✓
515821286	141 [286]	1	Standard	TY1256	✓	✓

K=80 [5.6] • 1/2" NPT • H=40 mm						
Art. No. Pendent С плоской розеткой Аşağı bakan	T °C [°F]	F	Response Реагирование Терки	SIN	VDS	CE
513711135	57 [135]	1	Quick/Быстр. реар./Hızlı	TY3236	✓	✓
513711155	68 [155]	1	Quick/Быстр. реар./Hızlı	TY3236	✓	✓
513711200	93 [200]	1	Quick/Быстр. реар./Hızlı	TY3236	✓	✓
513711286	141 [286]	1	Special/Специальные/Özel	TY3236	✓	✓
514711135	57 [135]	1	Special/Специальные/Özel	TY3246	✓	✓
514711155	68 [155]	1	Special/Специальные/Özel	TY3246	✓	✓
514711200	93 [200]	1	Special/Специальные/Özel	TY3246	✓	✓
514711286	141 [286]	1	Special/Специальные/Özel	TY3246	✓	✓
515711135	57 [135]	1	Standard	TY3256	✓	✓
515711155	68 [155]	1	Standard	TY3256	✓	✓
515711200	93 [200]	1	Standard	TY3256	✓	✓
515711286	141 [286]	1	Standard	TY3256	✓	✓

K=115 [8.0] • 3/4" NPT • H=46 mm						
Art. No. Pendent С плоской розеткой Аşağı bakan	T °C [°F]	F	Response Реагирование Терки	SIN	VDS	CE
513911135	57 [153]	1	Quick/Быстр. реар./Hızlı	TY4236	✓	✓
513911155	68 [155]	1	Quick/Быстр. реар./Hızlı	TY4236	✓	✓
513911200	93 [200]	1	Quick/Быстр. реар./Hızlı	TY4236	✓	✓
513911286	141 [286]	1	Special/Специальные/Özel	TY4236	✓	✓
514911135	57 [153]	1	Special/Специальные/Özel	TY4246	✓	✓
514911155	68 [155]	1	Special/Специальные/Özel	TY4246	✓	✓
514911200	93 [200]	1	Special/Специальные/Özel	TY4246	✓	✓
514911286	141 [286]	1	Special/Специальные/Özel	TY4246	✓	✓
515911135	57 [153]	1	Standard	TY4256	✓	✓
515911155	68 [155]	1	Standard	TY4256	✓	✓
515911200	93 [200]	1	Standard	TY4256	✓	✓
515911286	141 [286]	1	Standard	TY4256	✓	✓

RU Специальные спринклеры плоского орошения

TR Özel tepkili, yatay, yassi sprej



TFP635



0.100 kg



Art. No. 56006387, W-Type 6

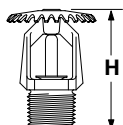

TY-FS

K=57 [4.0] • 3/8" ISO • H=55 mm

Art. No. Pendent С плоской розеткой Aşağı bakan	T °C [°F]	F	Response Реагирование Тепки	SIN	VDS	CE
513801135	57 [153]		Quick /Быстр. реар./Hızlı	TY1136	✓	✓
513801155	68 [155]		Quick /Быстр. реар./Hızlı	TY1136	✓	✓
513801200	93 [200]		Quick /Быстр. реар./Hızlı	TY1136	✓	✓
513801286	141 [286]		Special /Специальные /Özel	TY1136	✓	✓
514801135	57 [153]		Special /Специальные /Özel	TY1146	✓	✓
514801155	68 [155]		Special /Специальные /Özel	TY1146	✓	✓
514801200	93 [200]		Special /Специальные /Özel	TY1146	✓	✓
514801286	141 [286]		Special /Специальные /Özel	TY1146	✓	✓
515801135	57 [153]		Standard	TY1156	✓	✓
515801155	68 [155]		Standard	TY1156	✓	✓
515801200	93 [200]		Standard	TY1156	✓	✓
515801286	141 [286]		Standard	TY1156	✓	✓

K=80 [5.6] • 1/2" NPT • H=57 mm

Art. No. Pendent С плоской розеткой Aşağı bakan	T °C [°F]	F	Response Реагирование Тепки	SIN	VDS	CE
513701135	57 [153]		Quick /Быстр. реар./Hızlı	TY3136	✓	✓
513701155	68 [155]		Quick /Быстр. реар./Hızlı	TY3136	✓	✓
513701200	93 [200]		Quick /Быстр. реар./Hızlı	TY3136	✓	✓
513701286	141 [286]		Special /Специальные /Özel	TY3136	✓	✓
514701135	57 [153]		Special /Специальные /Özel	TY3146	✓	✓
514701155	68 [155]		Special /Специальные /Özel	TY3146	✓	✓
514701200	93 [200]		Special /Специальные /Özel	TY3146	✓	✓
514701286	141 [286]		Special /Специальные /Özel	TY3146	✓	✓
515701135	57 [153]		Standard	TY3156	✓	✓
515701155	68 [155]		Standard	TY3156	✓	✓
515701200	93 [200]		Standard	TY3156	✓	✓
515701286	141 [286]		Standard	TY3156	✓	✓

K=115 [8.0] • 3/4" NPT • H=60 mm

Art. No. Pendent С плоской розеткой Aşağı bakan	T °C [°F]	F	Response Реагирование Тепки	SIN	VDS	CE
513901135	57 [135]		Quick /Быстр. реар./Hızlı	TY4136	✓	✓
513901155	68 [155]		Quick /Быстр. реар./Hızlı	TY4136	✓	✓
513901200	93 [200]		Quick /Быстр. реар./Hızlı	TY4136	✓	✓
513901286	141 [286]		Special /Специальные /Özel	TY4136	✓	✓
514901135	57 [135]		Special /Специальные /Özel	TY4146	✓	✓
514901155	68 [155]		Special /Специальные /Özel	TY4146	✓	✓
514901200	93 [200]		Special /Специальные /Özel	TY4146	✓	✓
514901286	141 [286]		Special /Специальные /Özel	TY4146	✓	✓
515901135	57 [135]		Standard	TY4156	✓	✓
515901155	68 [155]		Standard	TY4156	✓	✓
515901200	93 [200]		Standard	TY4156	✓	✓
515901286	141 [286]		Standard	TY4156	✓	✓

RU Специальные спринклеры, защитные сдвоенные, DS21

TR Özel sprinklerler, çift baslikli emniyet sprinkleri, DS21



kg 2 kg

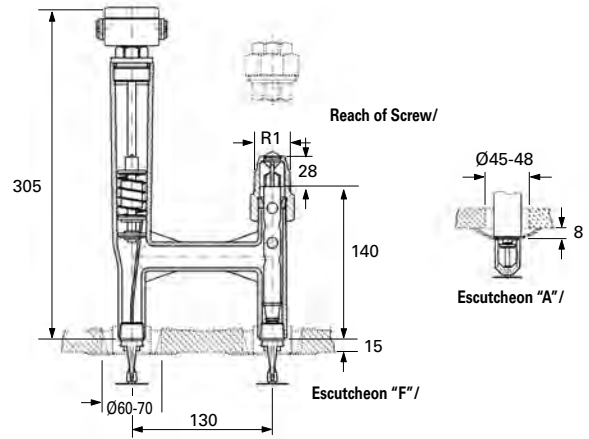

K=57 [4.0] • 1" ISO

Art. No.	Description / Описание / Tanımlama	T °C [°F]	F	VDS
815689	Sprinkler /Спринклер/Sprinkler	68 [155]	1/9	✓
816505	Monitoring Panel DSZ3000 /Контрольная панель DSZ3000/Monitör panosu DSZ3000			✓
816827	Accessories DSZ 3000 Panel /Принадлежности - панель DSZ 3000/Aksesuarlar, DSZ 3000 panosu			✓
815719	Interconnection Cable /Соединительный кабель/Ара bağlantı kablosu			✓
816712	Coupling for Extension /Удлиняющая муфта /Uzatma için kaplin			✓

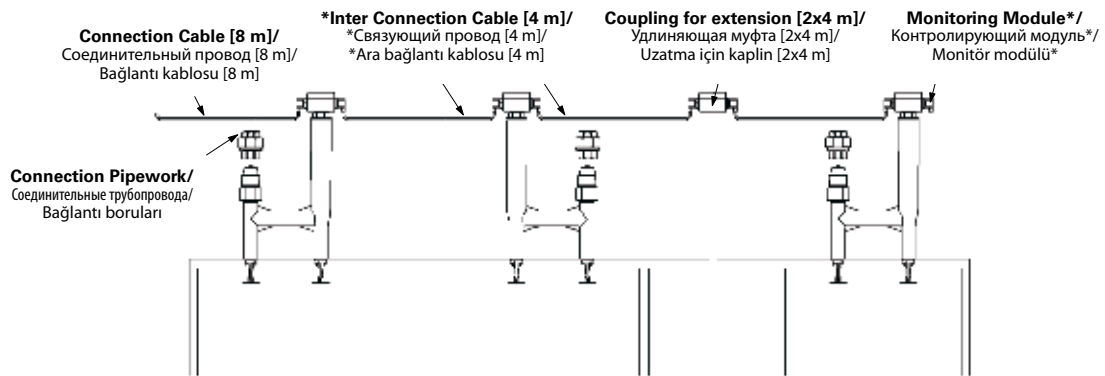

***Note:** Connection cable [8 m], monitoring module and mounting material are included in the accessories for monitoring panel.

*Примечание: Соединительный провод [8 м], контролирующий модуль и крепежный материал включены в принадлежности к контрольной панели.

*Not:Bağlantı kablosu [8 m], monitör modülü ve montaj için gereken her şey monitör panosunun aksesuarlarına dahildir

RU Специальные спринклеры, специальные материалы

TR Özel sprinklerler, özel ürünler



Kg 1.50 kg

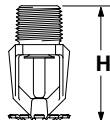

TY-B & TY-FRB

K=80[5.6] • 1/2" NPT • K=115[8.0]/3/4" NPT • H=55.6 mm

Material Материал Ürün	T °C [°F]
Titanium /Титан /Titanium	57 [135] - 182 [360]
6MO	57 [135] - 182 [360]
Stainless Steel /Нержавеющая сталь /Paslanmaz çelik	57 [135] - 182 [360]
Zeron 100	57 [135] - 182 [360]
Aluminium Bronze /Алюминиевая бронза /Aluminyum bronz	57 [135] - 182 [360]

* Available in Pendant, Upright and Conventional

* Есть с плоской розеткой, вогнутой розеткой и стандартные

* Aşağı bakan, yukarı bakan ve konvansiyonel olarak bulunur

K=80 [5.6] • 1/2" NPT • H=57 mm [2-3/16"]

Art. No.	T °C [°F]	F	Type Тип Tip	SIN
575710135	57 [135]	0	Pendent /С плоской розеткой /Aşağı bakan	TY8191
575710155	68 [155]	0	Pendent /С плоской розеткой /Aşağı bakan	TY8191
575710200	93 [200]	0	Pendent /С плоской розеткой /Aşağı bakan	TY8191
575710286	141 [286]	0	Pendent /С плоской розеткой /Aşağı bakan	TY8191
575710360	182 [360]	0	Pendent /С плоской розеткой /Aşağı bakan	TY8191
575700135	57 [135]	0	Upright /С вогнутой розеткой /Yukarı bakan	TY8291
575700155	68 [155]	0	Upright /С вогнутой розеткой /Yukarı bakan	TY8291
575700200	93 [200]	0	Upright /С вогнутой розеткой /Yukarı bakan	TY8291
575700286	141 [286]	0	Upright /С вогнутой розеткой /Yukarı bakan	TY8291
575700360	182 [360]	0	Upright /С вогнутой розеткой /Yukarı bakan	TY8291
575730135	57 [135]	0	Conventional /Традиционн. /Konvansiyonel	TY3651
575730155	68 [155]	0	Conventional /Традиционн. /Konvansiyonel	TY3651
575730200	93 [200]	0	Conventional /Традиционн. /Konvansiyonel	TY3651
575730286	141 [286]	0	Conventional /Традиционн. /Konvansiyonel	TY3651
575730360	182 [360]	0	Conventional /Традиционн. /Konvansiyonel	TY3651

TYCERTFP 03/07 Tyco reserves the right to change the contents without notice

Multiple Jet Controls, Single Inlet, Single Outlet

RU Многоструйные оросители, одиночное входное отверстие, одиночное выходное отверстие

TR Kontrol sprinklerleri 1 giriş, 1 çıkış

1



kg 1.50 kg

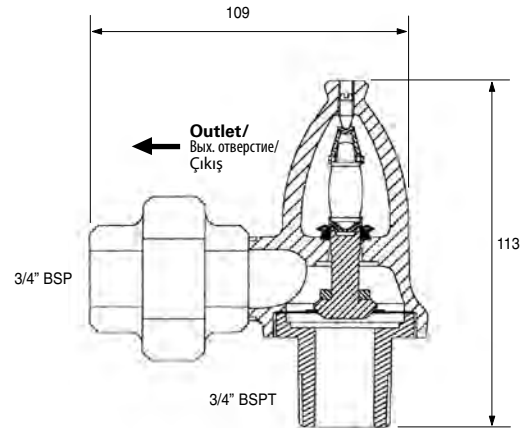

Art. No.	T °C [°F]	LPCB
MJCSO0027B	68 [155]	√
MJCSO0027D	79 [175]	√
MJCSO0027E	93 [200]	√
MJCSO0027G	141 [286]	√
MJCSO0027H	182 [360]	√
MJCSO0027I	227 [440]	√
MJCSO0027J	260 [500]	√

Multiple Jet Controls, Single Inlet, Double Outlet

RU Многоструйные оросители, одиночное входное отверстие, двойное выходное отверстие

TR Kontrol sprinklerleri 1 giriş, 2 çıkış



Kg 1.50 kg

MJCD

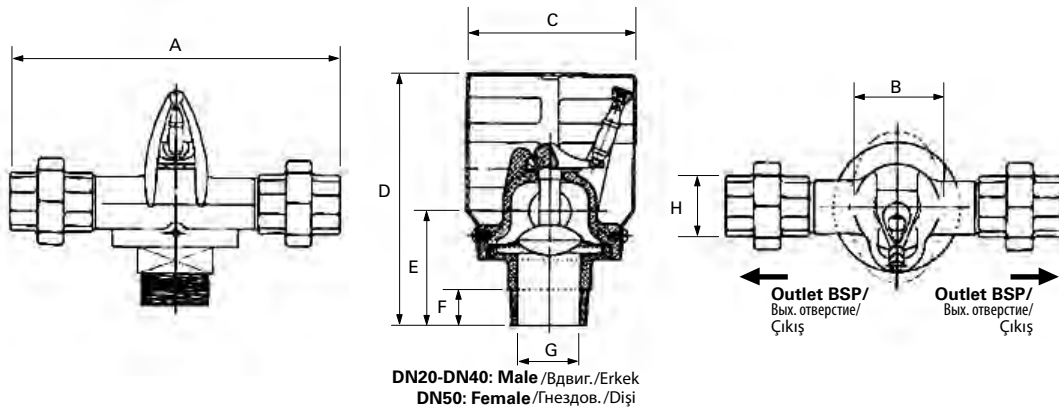

Art. No.	T °C [°F]	A mm	B mm	C mm	D mm	E mm	F mm	G DN	H DN	LPGB
MJCDO0027B	68 [155]	165	-	-	110	50	20	20 3/4"	20 3/4"	√
MJCDO0027D	79 [175]	165	-	-	110	50	20	20 3/4"	20 3/4"	√
MJCDO0027E	93 [200]	165	-	-	110	50	20	20 3/4"	20 3/4"	√
MJCDO0027G	141 [286]	165	-	-	110	50	20	20 3/4"	20 3/4"	√
MJCDO0027H	182 [360]	165	-	-	110	50	20	20 3/4"	20 3/4"	√
MJCDO0027I	227 [440]	165	-	-	110	50	20	20 3/4"	20 3/4"	√
MJCDO0027J	260 [500]	165	-	-	110	50	20	20 3/4"	20 3/4"	√
MJCDO0034B	68 [155]	196	67	105	148	60	23	25 1"	25 1"	√
MJCDO0034D	79 [175]	196	67	105	148	60	23	25 1"	25 1"	√
MJCDO0034E	93 [200]	196	67	105	148	60	23	25 1"	25 1"	√
MJCDO0034G	141 [286]	196	67	105	148	60	23	25 1"	25 1"	√
MJCDO0034H	182 [360]	196	67	105	148	60	23	25 1"	25 1"	√
MJCDO0034I	227 [440]	196	67	105	148	60	23	25 1"	25 1"	√
MJCDO0034J	260 [500]	196	67	105	148	60	23	25 1"	25 1"	√
MJCDO0048B	68 [155]	230	67	107	165	70	25	40 1.1/2"	25 1"	√
MJCDO0048D	79 [175]	230	67	107	165	70	25	40 1.1/2"	25 1"	√
MJCDO0048E	93 [200]	230	67	107	165	70	25	40 1.1/2"	25 1"	√
MJCDO0048G	141 [286]	230	67	107	165	70	25	40 1.1/2"	25 1"	√
MJCDO0048H	182 [360]	230	67	107	165	70	25	40 1.1/2"	25 1"	√
MJCDO0048I	227 [440]	230	67	107	165	70	25	40 1.1/2"	25 1"	√
MJCDO0048J	260 [500]	230	67	107	165	70	25	40 1.1/2"	25 1"	√
MJCDO0060B	68 [155]	225	69	136	182	60	25	50 2"	40 1.1/2"	√
MJCDO0060D	79 [175]	225	69	136	182	60	25	50 2"	40 1.1/2"	√
MJCDO0060E	93 [200]	225	69	136	182	60	25	50 2"	40 1.1/2"	√
MJCDO0060G	141 [286]	225	69	136	182	60	25	50 2"	40 1.1/2"	√
MJCDO0060H	182 [360]	225	69	136	182	60	25	50 2"	40 1.1/2"	√
MJCDO0060I	227 [440]	225	69	136	182	60	25	50 2"	40 1.1/2"	√
MJCDO0060J	260 [500]	225	69	136	182	60	25	50 2"	40 1.1/2"	√

TYCERTFP 03/07 Tyco reserves the right to change the contents without notice

Multiple Jet Controls, Double Inlet, Single Outlet

RU Многоструйные оросители, двойное входное отверстие, одиночное выходное отверстие

TR Kontrol sprinklerleri 2 giriş, 1 çıkış





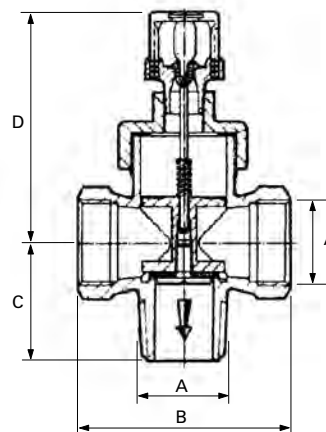







Kg 1.50 kg



Art. No.	T °C [°F]	A [BSP] "	Equivalent Length Эквивалентная длина Eşit uzunluk	B mm	C mm	D mm	VDS
2122206	68 [155]	1.1/4	1.8 m	105	58	110	√

RU Насадки

TR Nozullar

 MV	<p>Medium Velocity Средняя скорость орошения Orta yoğunluklu</p>	<p>P. 1.086</p>
 SEALED MV	<p>Medium Velocity Средняя скорость орошения Orta yoğunluklu</p>	<p>P. 1.087</p>
 MV-T	<p>Medium Velocity, Type Tank Top Средняя скорость орошения, для крепления сверху резервуара Orta yoğunluklu, tank tavanı tipi</p>	<p>P. 1.088</p>
 MV-R	<p>Medium Velocity, Reverse Acting Средняя скорость орошения, обратного действия Orta yoğunluklu, retroaktif</p>	<p>P. 1.088</p>
 TYPE A	<p>Drencher Дренчер Su perdesi nozulları</p>	<p>P. 1.089</p>
 WINDOW	<p>Window Wall Drencher Оконный/настенный дренчер Pencere tipi su perdesi nozulları</p>	<p>P. 1.089</p>
 D-3	<p>Protectospray Насадка Protectospray Protecto spreyi</p>	<p>P. 1.090</p>
 EA-1	<p>Protectospray Насадка Protectospray Protecto spreyi</p>	<p>P. 1.091</p>
 HV	<p>High Velocity Быстродействующая Yüksek yoğunluklu</p>	<p>P. 1.092</p>
 F822-F834	<p>Mulsifyre, 800 Series Насадка Mulsifyre, серия 800 Musifyre, 800 serisi</p>	<p>P. 1.093</p>
 TYPE 1 & 2	<p>Open Nozzles for Cooling Towers Открытые насадки для охлаждающих башень Soğutma kuleleri için açık nozullar</p>	<p>P. 1.094</p>

TYCERTFP 03/07 Tyco reserves the right to change the contents without notice

RU Насадки

TR Nozullar



ISSUE A

Exposure

Для внешней защиты
Düz püskürteç sprinklerleri

P. 1.095



ISSUE B

Exposure

Для внешней защиты
Düz püskürteç sprinklerleri

P. 1.095



B-1

Foam Water Sprinklers, Pendent

Спринклеры для пены и воды, с плоской розеткой
Köpüklü su sprinklerleri, aşağı bakan

P. 1.096



B-1

Foam Water Sprinklers, Upright

Спринклеры для пены и воды, с вогнутой розеткой
Köpüklü su sprinklerleri, yukarı bakan

P. 1.096



AM4

Aquamist

Тонкое распыление воды
Su sisi üreten sprinklerler (Aquamist)

P. 1.097



AM6 & AM11

Aquamist

Тонкое распыление воды
Su sisi üreten sprinklerler (Aquamist)

P. 1.097



AM10

Aquamist

Тонкое распыление воды
Su sisi üreten sprinklerler (Aquamist)

P. 1.098



AM22 & AM24

Aquamist

Тонкое распыление воды
Su sisi üreten sprinklerler (Aquamist)

P. 1.098



AM25

Aquamist

Тонкое распыление воды
Su sisi üreten sprinklerler (Aquamist)

P. 1.099

Nozzles, Medium Velocity, MV

RU Насадки л, средняя скорость орошения, MV

TR Nozullar, orta yoğunluklu, MV



kg 0.120 kg

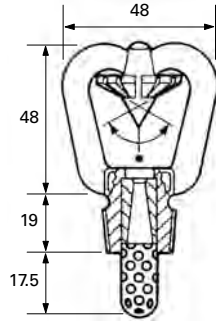

* Nozzles with an orifice smaller than 9.5 mm include a filter.

* Насадки с отверстием менее 9,5 мм включают в себя фильтр.

* 9,5 mm'den küçük orifslü nozullar bir süzgece sahiptir.

K-Factors		MV • 1/2" NPT											
		MV10	MV12	MV15	MV18	MV19	MV21	MV25	MV26	MV30	MV34	MV47	MV57
Ø	mm	5.10	5.40	6.30	6.80	7.10	7.70	8.30	8.80	9.00	9.60	11.2	12.60
	Inch	0.20	0.21	0.25	0.27	0.28	0.31	0.33	0.35	0.36	0.38	0.44	0.50
K	Metric	15.9	18.0	23.8	28.0	30.2	34.0	38.2	42.0	50.0	58.8	80.0	99.5
	USA	1.10	1.25	1.65	1.94	2.09	2.36	2.65	2.91	3.47	4.07	5.54	6.90

Min. 1.4 bar [20 psi]

Art. No.		90°	95°	110°	125°	140°	160°	LPCB	FM	UL	PAVUS	T/S/U
MV10	AED03829	AEA02524	AEA02533	AEA02542	AEA02551	AEA02560	√	√	√	√	√	√
MV12	AED03838	AED03847	AED03856	AED03865	AED03874	AED03883	√	√	√	√	√	√
MV15	AEA03892	AEA02588	AEA02597	AEA02609	AEA02618	AEA02627	√	√	√	√	√	√
MV18	AED03904	AED03913	AED03922	AED03931	AED03940	AED03959	√	√	√	√	√	√
MV19	AED03968	AEA02645	AEA02654	AEA02663	AEA02672	AEA02681	√	√	√	√	√	√
MV21	AED03977	AED03986	AED03995	AED04004	AED04013	AED04022	√	√	√	√	√	√
MV25	AED04031	AEA02702	AEA02711	AEA02720	AEA02739	AEA02748	√	√	√	√	√	√
MV26	AED04040	AED04059	AED04068	AED04077	AED04086	AED04095	√	√	√	√	√	√
MV30	AED04107	AED04116	AED04125	AED04134	AED04143	AED04152	√	√	√	√	√	√
MV34	AED04161	AED00949	AED00958	AED00967	AED00976	AED00985	√	√	√	√	√	√
MV47	AED04170	AED01003	AED01012	AED01021	AED01030	AED01049	√	√	√	√	√	√
MV57	AED04189	AED01067	AED01076	AED01085	AED01094	AED01106	√	√	√	√	√	√

Art. No.		90°	95°	110°	125°	140°	160°	VDS	PAVUS	T/S/U
MV10	AED07063	AED00024	AED00033	AED00042	AED00051	AED02560	√	√		
MV12	AED07612	AED07621	AED07630	AED07649	AED07658	AED07667	√	√		
MV15	AED07676	AED00088	AED00097	AED00109	AED00118	AED00127	√	√	√	√
MV18	AED07685	AED07694	AED07706	AED07715	AED07724	AED07733	√	√		
MV19	AED07742	AED00145	AED00154	AED00163	AED00172	AED00181	√	√	√	√
MV21	AED07760	AED07779	AED07788	AED07797	AED07809	AED07818	√	√		
MV25	AED07751	AED00202	AEA00211	AED00220	AEA00239	AEA00248	√	√	√	√
MV26	AED07827	AED07836	AEA07845	AED07854	AED07863	AED07872	√	√		
MV30	AED07881	AED07890	AED07902	AED07911	AED07920	AED07939	√	√		
MV34	AED07948	AED01218	AED01227	AED01236	AED01245	AED01254	√	√	√	√
MV47	AED07957	AED01272	AED01281	AED01290	AED01302	AED01311	√	√	√	√
MV57	AED07966	AED01339	AED01348	AED01357	AED01366	AED01375	√	√		

* Nozzles can be coated or made in special material on request.

* Spray patterns are available on request.

* По запросу насадки могут покрываться специальным материалом или изготавливаться из него.

* Рисунок распыления - по запросу.

* Nozullar istek üzerine özel bir maddeden üretilebilir veya kaplanabilir.

* Farklı sprey şekilleri için bize danışabilirsiniz.

TYCERTFP 03/07 Tyco reserves the right to change the contents without notice

Nozzles, Medium Velocity, Sealed MV

RU Насадки, средняя скорость орошения, герметизированные MV

TR Nozullar, orta yoğunluklu, kapamalı MV



Kg 0.120 kg

Art. No. 560006387, W-Type 6

[P.1.117]

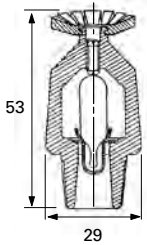

Art. Nr. • MV47 • K=80 [5.6] • 1/2" NPT • Bronze

T °C	90°	95°	110°	125°	140°	160°	LPCB
57	29396	28402	28408	28414	28420	28426	√
68	28397	28403	28409	28415	28421	28427	√
79	28398	28404	28410	28416	28422	28428	√
93	28399	28405	28411	28417	28423	28429	√
141	28400	28406	28412	28418	28424	28430	√
182	28401	28407	28413	28419	28425	28431	√

Min. 1.4 bar [20 psi]

Art. Nr. • MV34 • K=57 [4.0] • 10 mm BSPT • Bronze

T °C	90°	95°	110°	125°	140°	160°	LPCB
57	28432	28438	28444	28450	28456	28462	√
68	28433	28439	28445	28451	28457	28463	√
79	28434	28440	28446	28452	28458	28464	√
93	28435	28441	28447	28453	28459	28465	√
141	28436	28442	28448	28454	28460	28466	√
182	28437	28443	28449	28455	28461	28467	√

Min. 1.4 bar [20 psi]

* Nozzles can be coated or made in special material on request.

* Spray patterns are available on request.

* По запросу насадки могут покрываться специальным материалом или изготавливаться из него.

* Рисунок распыления - по запросу.

* Nozullar istek üzerine özel bir maddeden üretilebilir veya kaplanabilir.

* Farklı sprey şekilleri için bize danışabilirsiniz.

Nozzles, Medium Velocity, Type Tank Top and Reverse Acting MV

RU Насадки орошения, средняя скорость, для верхней части резервуаров и обратного действия, MV

TR Nozullar, orta yogunluklu, tank tavanı tipi ve retroaktif MV



MV-T

Kg 0.120 kg

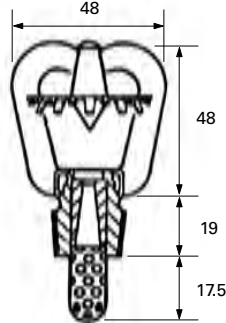

1/2" NPT • Bronze • $\angle 125^\circ$			
Nozzle	MV-T	K	LPCB
MV10	28285	15.9	✓
MV12	28281	18.0	✓
MV15	28282	23.8	✓
MV18	28286	28.0	✓
MV19	28287	30.2	✓
MV21	28288	34.0	✓
MV25	28289	38.2	✓
MV26	28289	42.0	✓
MV30	28290	50.0	✓
MV34	28291	58.8	✓
MV47	28292	80.0	✓
MV57	28293	99.5	✓

Min. 1.4 bar [20 psi]

* Sprayers with an orifice size of 9.5 mm and under are fitted with a strainer.

* Распылители с диаметром отверстия 9,5 мм и меньше оснащены фильтром.

* 9,5 mm'den küçük orifisli püskürteçler bir süzgece sahiptir.



MV-R

Kg 0.120 kg

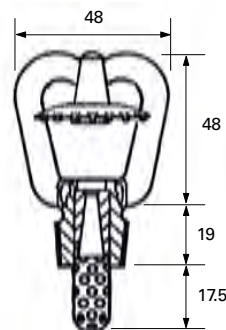

1/2" NPT • Bronze • $\angle 125^\circ$			
Nozzle	MV-R	K	LPCB FM
MV10	28383	15.9	✓ ✓
MV12	28384	18.0	✓ ✓
MV15	28385	23.8	✓ ✓
MV18	28386	28.0	✓ ✓
MV19	28387	30.2	✓ ✓
MV21	28388	34.0	✓ ✓
MV25	28389	38.2	✓ ✓
MV26	28390	42.0	✓ ✓
MV30	28391	50.0	✓ ✓
MV34	28392	58.8	✓ ✓
MV47	28393	80.0	✓ ✓
MV57	28394	99.5	✓ ✓

Min. 1.4 bar [20 psi]

* Nozzles can be coated or made in special material on request.

* Spray patterns are available on request.

* По запросу насадки могут покрываться специальным материалом или изготавливаться из него.

* Рисунок распыления - по запросу.

* Nozullar istek üzerine özel bir maddeden üretilebilir veya kaplanabilir.

* Farklı sprey şekilleri için bize danışabilirsiniz.

TYCERTFP 03/07 Tyco reserves the right to change the contents without notice

Nozzles, Type A Drencher

RU Насадки, дренчер типа А

TR Nozullar, A tipi su perdesi nozulları



TYPE A

Kg 0.120 kg

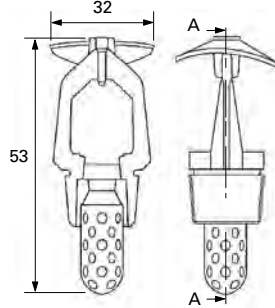

1/2" NPT • Bronze				
T	Ø 6 mm	K	Ø 10 mm	K
-	28592	25	28593	43
57° C	28555	25	28560	43
68° C	27007	25	27008	43
79° C	28556	25	27038	43
93° C	28557	25	28561	43
141° C	28558	25	28562	43

Min. 1.4 bar [20 psi]

* Nozzles can be coated or made in special material on request.

* Spray patterns are available on request.

* По запросу насадки могут покрываться специальным материалом или изготавливаться из него.

* Рисунок распыления - по запросу.

* Nozullar istek üzerine özel bir maddeden üretilebilir veya kaplanabilir.

* Farklı sprey şekilleri için bize danışabilirsiniz.

Nozzles, Type Window Wall Drencher

RU Насадки, дренчер оконно-настенный

TR Nozullar, pencere tipi su perdesi



WINDOW

Kg 0.120 kg

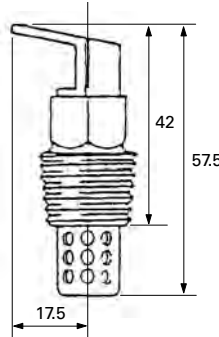

1/2" ISO • Bronze		
Art. No.	Nom. Ø mm	K
26438	6	24
26439	10	40.5

Min. 1.4 bar [20 psi]

* Nozzles can be coated or made in special material on request.

* Spray patterns are available on request.

* По запросу насадки могут покрываться специальным материалом или изготавливаться из него.

* Рисунок распыления - по запросу.

* Nozullar istek üzerine özel bir maddeden üretilebilir veya kaplanabilir.

* Farklı sprey şekilleri için bize danışabilirsiniz.

Nozzles, Protectospray D-3

RU Насадки, Protectospray D-3

TR Nozullar, Protecto spreyi D-3



D-3



TFP802



0.120 kg



[P.1.117]

Art. No. 564521001, Model F799

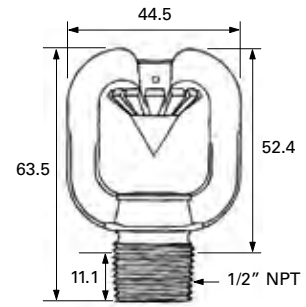

D-3 • 1/2" NPT • H=63.5 mm [2-1/2"]

Nozzle	Ø mm	K	FM	UL
No. 16	5.16	17.3 [1.2]	√	√
No. 18	6.35	25.9 [1.8]	√	√
No. 21	7.14	33.1 [2.3]	√	√
No. 24	8.33	43.2 [3.0]	√	√
No. 28	9.53	59.0 [4.1]	√	√
No. 32	11.13	80.6 [5.6]	√	√
No. 34	12.70	103.7 [7.2]	√	√

ART. NR. 49 - 3XX - X - XXX

Ø		Finish & Material/Покрытие и материал /Kaplama & madde		∠	
16	No.206" [1/2" NPT]	1	Plain Brass /Латунь /Düz pirinç	065	65°
18	No.250" [1/2" NPT]	7	Leaded Coated Brass /Свинцовая латунь с покрытием/Kurşun kaplamalı pirinç	080	80°
21	No.281" [1/2" NPT]	4	Teflon Coated Brass /Латунь с покрытием Teflon /Teflon kaplamalı pirinç	095	95°
24	No.328" [1/2" NPT]	9	Chrome Plated Brass /Хромированная латунь /Krom kaplamalı	110	110°
28	No.375" [1/2" NPT]	0	Plain Stainless Steel [1/2" NPT only] /Нержавеющая углеродистая сталь [только NPT 1/2"] / Düz paslanmaz çelik [sadece 1/2" NPT]	125	125°
32	No.438" [1/2" NPT]			140	140°
34	No.500" [1/2" NPT]			160	160°
				180	180°

TYCERTFP 03/07 Tyco reserves the right to change the contents without notice

Nozzles, Protectospray EA-1

RU Насадки, Protectospray EA-1

TR Nozullar, Protecto spreyi EA-1

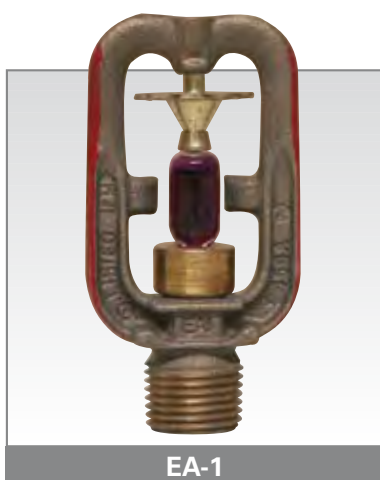

EA-1



TFP800



0.120 kg



Art. No. 564521001, Model F799

[P.1.117]

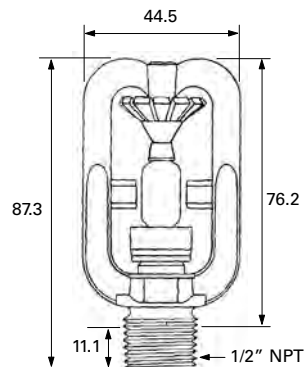

EA-1 • 1/2" NPT • H=87.3 mm [3-7/16"]

Ø mm ["]	K	FM	UL
6 [1/4]	20.2 [1.4]	√	√
10 [3/8]	40.3 [2.8]	√	√
15 [1/2]	80.6 [5.6]	√	√

ART. NR. 49 - XXX - X - XXX

Ø		∠		Finish & Material / Покрытие и материал / Kaplama & madde		°C [F]	
9	1/2" [1/2" NPT]	65	65°	1	Plain Brass / Латунь / Düz pirinç	135	57 [135]
8	3/8" [1/2" NPT]	80	80°	7	Leaded Coated / Свинцов., с покрытием / Kurşun kaplamalı	175	79 [175]
7	1/4" [1/2" NPT]	95	95°	9	Chrome Plated / С хром. покрытием / Krom kaplamalı	250	121 [250]
		10	110°	6	Corroproof [1/2" NPT only] / Корр. стойкость [только NPT 1/2" / Corroproof [sadece 1/2" NPT]	325	163 [325]
		25	125°			400*	204 [400]
		40	140°			500*	260 [500]
		60	160°				
		81	180°				

*Available in plainbrass / Есть из латуни / Pirinç olarak bulunur

TYCERTFP 03/07 Tyco reserves the right to change the contents without notice

Nozzles, High Velocity, Model HV

RU Насадки, высокая скорость орошения, модель HV

TR Nozullar, yüksek yoğunluklu, model HV



TFP815



0.120 kg

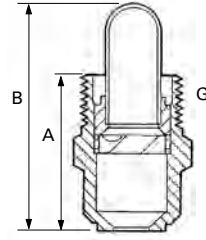

HV

Type	Art. No. Bronze Бронза Bronz	G BSPT	K	A	B	LPCB	FM	UL
HV14	PBP55062	1"	23.0 [1.6]	47.6	71.0	√	√	√
HV17	PBP55071	1"	26.0 [1.8]	47.6	72.0	√	√	√
HV26	PBP55080	1"	41.8 [2.9]	47.6	71.5	√	√	√
HV37	PBP55099	1"	62.0 [4.3]	51.6	75.2	√	√	√
HV45	PBP55101	1"	79.2 [5.5]	51.6	75.6	√	√	√
HV60	AEC00236	1.1/4"	86.4 [6.0]	86.5	15.5	√	√	√

Type	Art. No. Stainless Steel 316 Нержавеющая сталь 316 Paslanmaz çelik 316	G BSPT	K	A	B	LPCB	FM	UL
HV14	AEC00012	1"	23.0 [1.6]	47.6	71.0	√	√	√
HV17	AEC00021	1"	26.0 [1.8]	47.6	72.0	√	√	√
HV26	AEC00030	1"	41.8 [2.9]	47.6	71.5	√	√	√
HV37	AEC00049	1"	62.0 [4.3]	51.6	75.2	√	√	√
HV45	AEC00058	1"	79.2 [5.5]	51.6	75.6	√	√	√
HV60	AEC00263	1.1/4"	86.4 [6.0]	86.5	15.5	√	√	√

* Nozzles can be coated or made in special material on request.

* Spray patterns are available on request.

* По запросу насадки могут покрываться специальным материалом или изготавливаться из него.

* Рисунок распыления - по запросу.

* Nozullar istek üzerine özel bir maddeden üretilebilir veya kaplanabilir.

* Farklı sprey şekilleri için bize danışabilirsiniz.

RU Насадки Mulsifyre, серия 800

TR Nozullar, Musifyre, 800 serisi



TFP810



0.120 kg

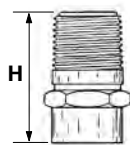

Type 1

Without Blow-Off Cap/
Без спускного копчака/
Blow-off kapaksız (atlan kapaksız)

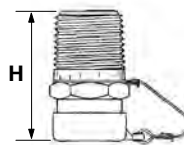

Type 2

With Dust Cap/
С пылезащитным копчаком/
Toz kapak ile

Type 1 • 3/4" NPT

Art. No.	Model	K	F	H mm ["]	FM	UL
498001822	F822	28.8 [2.0]	1	42 [1-5/8]	√	√
498001824	F824	33.12 [2.3]	1	42 [1-5/8]	√	√
498001826	F826	37.44 [2.6]	1	42 [1-5/8]	√	√
498001828	F828	38.88 [2.7]	1	43 [1-11/16]	√	√
498001832	F832	66.24 [4.6]	1	47 [1-13/16]	√	√
498001834	F834	73.44 [5.1]	1	70 [1-3/4]	√	√

Type 2 • 3/4" NPT

Art. No.	Model	K	F	H mm ["]	FM	UL
498011822	F822	28.8 [2.0]	1	42 [1-5/8]	√	√
498011824	F824	33.12 [2.3]	1	42 [1-5/8]	√	√
498011826	F826	37.44 [2.6]	1	42 [1-5/8]	√	√
498011828	F828	38.88 [2.7]	1	43 [1-11/16]	√	√
498011832	F832	66.24 [4.6]	1	47 [1-13/16]	√	√
498011834	F834	73.44 [5.1]	1	70 [1-3/4]	√	√

Nozzles, Open Nozzles for Cooling Towers, Type 1 & 2

RU Насадки, открытые насадки для охлаждающих башень, тип 1 и 2

TR Nozullar, soğutma kuleleri için açık nozullar, tip 1 ve 2



TYPE 1 & 2



TFP830



0.120 kg



[P.1.117]

Art. No. 564521001, Model F799

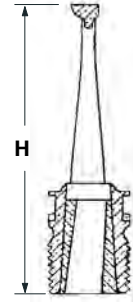

K=41.8 [2.9] • 3/4" NPT • H=76.2 mm [3"]

Art. No.	Type	F	UL
500811000	1	1	√
500821001	2	1	√

RU Насадки Д, спринклеры для внешней защиты, модель А и В

TR Nozullar, düz püskürteç sprinklerleri, A ve B modelleri



ISSUE A



TFP835



0.120 kg



1/2" NPT • H=42.9 mm [1-11/16"]

Art. No.	Ø	K	F	UL	FM
492001001	1/4"	26 [1-6/7]	1	√	√
492009001	1/4"	26 [1-6/7]	9	√	√
492001002	5/16"	37 [2-5/8]	1	√	√
492009002	5/16"	37 [2-5/8]	9	√	√
492001003	3/8"	58 [4-1/12]	1	√	√
492009003	3/8"	58 [4-1/12]	9	√	√



ISSUE B



TFP835



0.120 kg

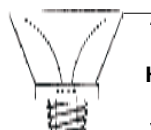

3/4" NPT • H=60.3 mm [2-3/8"]

Art. No.	Ø	K	F	UL
492011004	1/2"	82 [5-3/4]	1	√
492017004	1/2"	82 [5-3/4]	9	√
492011005	5/8"	123 [8-3/5]	1	√
492017005	5/8"	123 [8-3/5]	9	√
492011006	3/4"	177 [12-3/7]	1	√
492014006	3/4"	177 [12-3/7]	9	√

Nozzles, Foam Water Sprinklers, B-1

RU Насадки, спринклеры для пены и воды, B-1

TR Nozullar, köpüklü su sprinklerleri, B-1



 TFP840

 0.550 kg

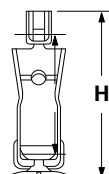

B1

K=40 [3.0] • 1/2" NPT • H=148 mm [5-13/16"]

Art. No. Pendent С плоской розеткой Aşağı bakan	F	UL
492111001	1	√
F72535	1	

K=20 [1.4] • 1/2" NPT • H=148 mm [5-13/16"]

Art. No. Pendent С плоской розеткой Aşağı bakan	F
F72536	1

K=80 [5.6] • 1/2" NPT • H=148 mm [5-13/16"]

Art. No. Pendent С плоской розеткой Aşağı bakan	F
100274	1



 TFP840

 0.550 kg

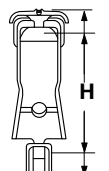

B1

K=40 [3.0] • 1/2" NPT • H=148 mm [5-13/16"]

Art. No. Upright С вогнутой розеткой Yukarı bakan	F	UL
492101001	1	√

TYCERTFP 03/07 Tyco reserves the right to change the contents without notice

Nozzles, Aquamist, Type AM4 & AM6 & AM11

RU Насадки для тонкого распыления воды, тип AM4 и AM6 и AM11

TR Nozullar, su sisi üreten, AM4, AM6 ve AM11 tipleri



AM4

 TD 1173

 Art. No. 568504001, W-Type 7
[P.1.117]



K=3.5 [0.24] • 1/2" NPT • H=50.8 mm [2"]

Art. No.	F	FM	UL	VNIPO
492040001	0	√	√	√
492040011	0	√	√	√



AM6 & AM11

 TD 1170

 0.120 kg

 Art. No. 568504001, W-Type 7
[P.1.117]

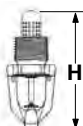

AM6 • K=4.7 [0.33] • 1/2" NPT • H=61 mm [2-13/32"]

Art. No.	T °C [°F]	F	UL
492061135	57 [135]	1	√
492064135	57 [135]	4	√
492069135	57 [135]	9	√
492060135	57 [135]	0	√
492061155	68 [155]	1	√
492064155	68 [155]	4	√
492069155	68 [155]	9	√
492060155	68 [155]	0	√
492061175	79 [175]	1	√
492064175	79 [175]	4	√
492069175	79 [175]	9	√
492060175	79 [175]	0	√
492061200	93 [200]	1	√
492064200	93 [200]	4	√
492069200	93 [200]	9	√
492060200	93 [200]	0	√

AM11 • K=4.7 [0.33] • 1/2" NPT • H=61 mm [2-13/32"]

Art. No.	T °C [°F]	F	UL
492081135	57 [135]	1	√
492084135	57 [135]	4	√
492089135	57 [135]	9	√
492081155	68 [155]	1	√
492084155	68 [155]	4	√
492089155	68 [155]	9	√
492081175	79 [175]	1	√
492084175	79 [175]	4	√
492089175	79 [175]	9	√
492081200	93 [200]	1	√
492084200	93 [200]	4	√
492089200	93 [200]	9	√

TYCERTFP 03/07 Tyco reserves the right to change the contents without notice

RU Насадки для тонкого распыления воды, тип AM10 и AM22 и AM24

TR Nozullar, su sisi üreten, AM10, AM22 ve AM24 tipleri



AM10



TD 1174



0.120 kg



Art. No. 568504001, W-Type 7

[P.1.117]



K=3.5 [0.24] • 1/2" NPT • H=50.8 mm [2"]

Art. No.	F	FM	UL
492070001	0	√	√

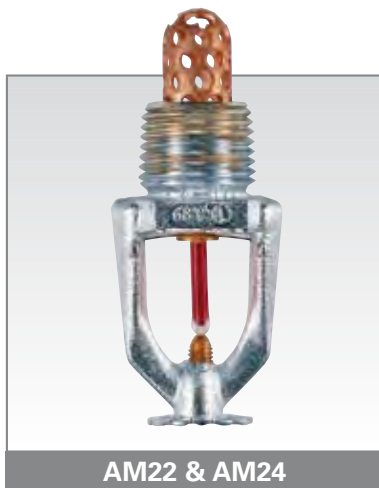

AM22 & AM24



TD 1170



0.120 kg



Art. No. 568504001, W-Type 7

[P.1.117]



AM22 • K=9.2 [0.64] • 1/2" NPT • H=59 mm [2-5/16"]

Art. No.	T °C [°F]	F	UL
492091135	57 [135]	1	√
492094135	57 [135]	4	√
492099135	57 [135]	9	√
492091155	68 [155]	1	√
492094155	68 [155]	4	√
492099155	68 [155]	9	√
492091175	79 [175]	1	√
492094175	79 [175]	4	√
492099175	79 [175]	9	√
492091200	93 [200]	1	√
492094200	93 [200]	4	√
492099200	93 [200]	9	√

AM24 • K=9.2 [0.64] • 1/2" NPT • H=59 mm [2-5/16"]

Art. No.	T °C [°F]	F	UL
492101135	57 [135]	1	√
492104135	57 [135]	4	√
492109135	57 [135]	9	√
492101155	68 [155]	1	√
492104155	68 [155]	4	√
492109155	68 [155]	9	√
492101175	79 [175]	1	√
492104175	79 [175]	4	√
492109175	79 [175]	9	√
492101200	93 [200]	1	√
492104200	93 [200]	4	√
492109200	93 [200]	9	√

TYCERTFP 03/07 Tyco reserves the right to change the contents without notice

Nozzles, Aquamist, Type AM25

RU Насадки для тонкого распыления воды, тип AM25

TR Nozullar, su sisi üreten, AM10, AM22 ve AM24 tipleri



AM25



TD 1172H



0.120 kg



Art. No. 568504001, W-Type 7

[P.1.117]













K=9.2 [0.64] • 1/2" NPT • H=76.1 mm [3.0"]

Art. No.	T °C [°F]	F	VNIPO
492251135	57 [135]	1	
492254135	57 [135]	4	
492259135	57 [135]	9	
492251155	68 [155]	1	✓
492254155	68 [155]	4	✓
492259155	68 [155]	9	✓
492251175	79 [175]	1	
492254175	79 [175]	4	
492259175	79 [175]	9	
492251200	93 [200]	1	
492254200	93 [200]	4	
492259200	93 [200]	9	

RU Принадлежности для спринклеров

TR Sprinkler aksesuarlar

	<p>Recessed Escutcheons Утопленные подрозетники Gömme rozetler</p>	1.102
STYLE 10, 20, 30, 40 & 50		
	<p>One Piece Escutcheons Однокомпонентные подрозетники Tek parça rozetler</p>	1.103
ONE PIECE		
	<p>Hinged Escutcheons Петлевые подрозетники Menteşeli rozetler</p>	1.103
HINGED		
	<p>Sprinkler Head Cabinets Шкафы для спринклерных головок Sprinkler dolapları</p>	1.104
CABINET		
	<p>Sprinkler Guards, Pendent Спринклерные ограждения, с плоской розеткой Sprinkler koruması, aşağı bakan</p>	1.105
G1 & G4		
	<p>Sprinkler Guards, Upright Спринклерные ограждения, с вогнутой розеткой Sprinkler koruması, yukarı bakan</p>	1.105
G1/S1&G4/S4		
	<p>Sprinkler Guards, Pendent Спринклерные ограждения, с плоской розеткой Sprinkler koruması, aşağı bakan</p>	1.106
G2		
	<p>Sprinkler Guards, Upright Спринклерные ограждения, с вогнутой розеткой Sprinkler koruması, yukarı bakan</p>	1.106
WSG2		
	<p>Sprinkler Guards, Pendent Спринклерные ограждения, с плоской розеткой Sprinkler koruması, aşağı bakan</p>	1.107
TYPE 011		
	<p>Sprinkler Guards, Pendent Спринклерные ограждения, с плоской розеткой Sprinkler koruması, aşağı bakan</p>	1.107
GUARD 2-SCREW		
	<p>Sprinkler Guards, Upright Спринклерные ограждения, с вогнутой розеткой Sprinkler koruması, yukarı bakan</p>	1.107
GUARD 2-SCREW		

TYCERTFP 03/07 Tyco reserves the right to change the contents without notice

RU Принадлежности для спринклеров

TR Sprinkler aksesuarlar



MODEL GU

Sprinkler Guards, Pendent

Спринклерные ограждения, с плоской розеткой
Sprinkler koruması, aşağı bakan

P. 1.108



MODEL GU

Sprinkler Guards, Upright

Спринклерные ограждения, с вогнутой розеткой
Sprinkler koruması, yukarı bakan

P. 1.108



Sprinkler Wrenches

Спринклерные ключи
Sprinkler anahtarları

P. 1.109

Sprinkler Accessories, Recessed Escutcheons, Style 10, 20, 30, 40 & 50

RU Спринклерные аксессуары, утопленные подрозетники, стиль 10, 20, 30, 40 и 50

TR Sprinkler aksesuarları, gömme rozetler, 10, 20, 30, 40 ve 50 tipleri



STYLE 10, 20, 30, 40 & 50



TFP 770



0.035 kg

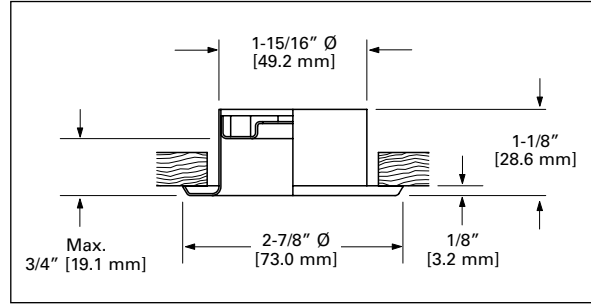

19 mm [3/4"] Adjustment / Настройка / Ayarlama

Art. No.	F	LPCB	FM	UL
567019010	9	√	√	√
567013010	3	√	√	√
567014010	4	√	√	√
567012010	1	√	√	√

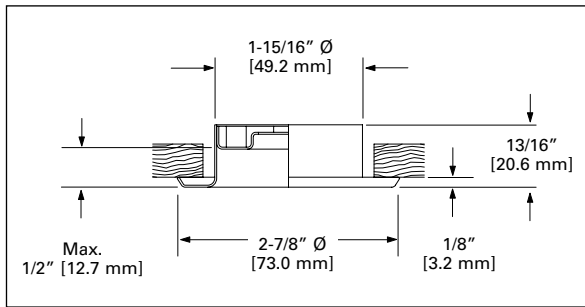

Style 20 • 1/2" NPT

12.7 mm [1/2"] Adjustment / Настройка / Ayarlama

Art. No.	F	LPCB	UL
567059010	9	√	√
567053010	3	√	√
567054010	4	√	√
567052010	1	√	√

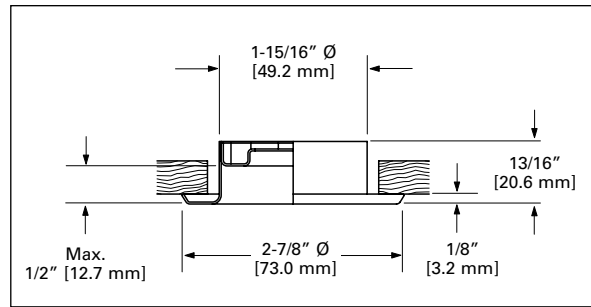

Style 30 • 3/4" NPT

12.7 mm [1/2"] Adjustment / Настройка / Ayarlama

Art. No.	F	LPCB	UL
567059011	9	√	√
567053011	3	√	√
567054011	4	√	√
567052011	1	√	√

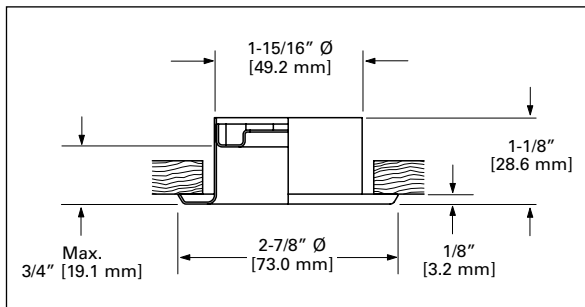

Style 40 • 3/4" NPT

19 mm [3/4"] Adjustment / Настройка / Ayarlama

Art. No.	F	LPCB	FM	UL
567009010	9	√	√	√
567003010	3	√	√	√
567004010	4	√	√	√
567002010	1	√	√	√

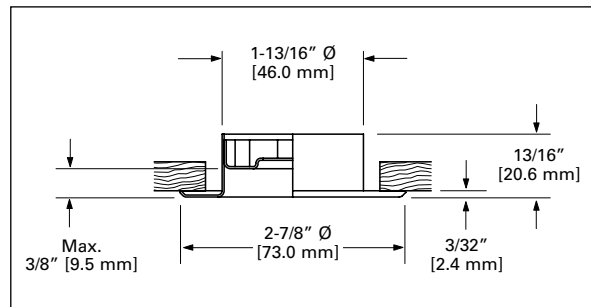

Style 50 • 1/2" NPT

9.5 mm [3/8"] Adjustment / Настройка / Ayarlama

Art. No.	F	FM	UL
567119010	9	√	√
567113010	3	√	√
567114010	4	√	√
567111010	1	√	√

*Approval valid in combination with sprinkler model

*Сертификация действительна при сочетании с моделью спринклера

*Onay sprinkler modeline göre geçerlidir

TYCERTFP 03/07 Tyco reserves the right to change the contents without notice

Sprinkler Accessories, One Piece Escutcheons

RU Спринклерные аксессуары, подрозетники, состоящие из одной детали

TR Sprinkler aksesuarları, tek parça rozetler



Kg 0.025 kg

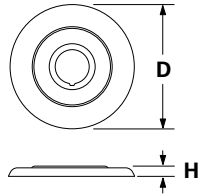

ONE PIECE

Art. No.	F	Ø	D mm	H mm
ESCSTDCH10	9	3/8"	75	5
ESCSTDRA10	3	3/8"	75	5
ESCSTDWH10	4	3/8"	75	5
ESCSTDSS10	0	3/8"	75	5
ESCSTDCH15	9	1/2"	75	5
ESCSTDRA15	3	1/2"	75	5
ESCSTDWH15	4	1/2"	75	5
ESCSTDSS15	0	1/2"	75	5
ESCSTDCH20	9	3/4"	75	5
ESCSTDRA20	3	3/4"	75	5
ESCSTDWH20	4	3/4"	75	5
ESCSTDSS20	0	3/4"	75	5

Sprinkler Accessories, Hinged Escutcheons

RU Спринклерные аксессуары, петлевые подрозетники

TR Sprinkler aksesuarları, menteşeli rozetler

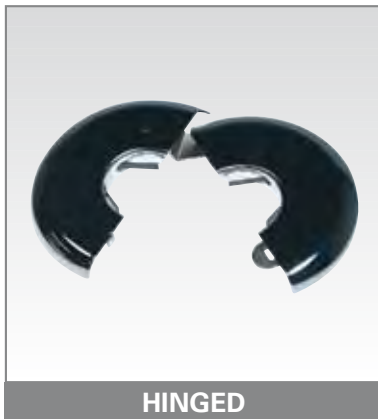

Kg 0.025 kg

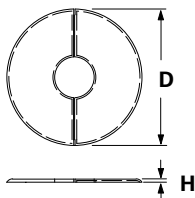

HINGED

Art. No.	F	Ø	D	H mm
ESCHINCH15	9	1/2"	70	8
ESCHINCH20	9	3/4"	73	8
ESCHINCH25	9	1"	86	8
ESCHINCH32	9	1-1/4"	92	8
ESCHINCH40	9	1-1/2"	98	8
ESCHINCH50	9	2"	112	8

TYCERTFP 03/07 Tyco reserves the right to change the contents without notice

RU Спринклерные аксессуары, шкафы для спринклерных головок

TR Sprinkler aksesuarları, sprinkler dolapları

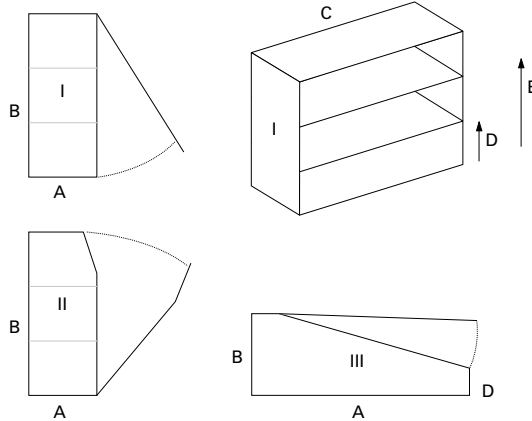
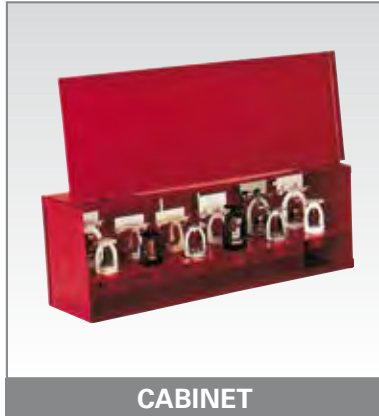

Art. No.	Sprinkler		Model	A mm	B mm	C mm	D mm	E mm	W Kg	Finish Покрытие Kaplama
	Capacity Вместимость Kapasite	Connection Соединение Bağlantı								
00869	36	1/2" 3/4"	II	180	265	385	50	150	2.5	Red/Красн./Kırmızı
SP50001	50	**	III	320	150	470	50	-	7.0	Red/Красн./Kırmızı
0240012	12	1/2" 3/4"*	I	103	132	363	45	-	1.4	Red/Красн./Kırmızı
0240006	6	1/2" 3/4"*	I	64	130	355	42	126	1.0	Red/Красн./Kırmızı
0240306	6	3/4" 1"***	I	80	160	357	46	-	1.4	Red/Красн./Kırmızı

- * Also suitable for ESFR-1, ESFR-17
- ** No perforated shelf
- *** Also suitable for ESFR-1, ESFR-17, ESFR-25

- * Также подходят для ESFR-1, ESFR-17
- ** Без перфорированных полок
- *** Также подходят для ESFR-1, ESFR-17, ESFR-25

- * ESFR-1 ve ESFR-17 için de uygundur
- ** Rafta sprinklerler için montaj delikleri bulunmamaktadır
- *** ESFR-1, ESFR-17 ve ESFR-25 için de uygundur

RU Спринклерные аксессуары, спринклерные ограждения

TR Sprinkler aksesuarları, sprinkler korumaları



TFP 780

0.08 kg

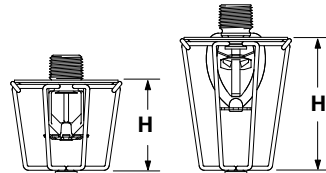

G1 & G4

G1 • TY-B & TY-FRB • 1/2" NPT & 3/4" NPT

Art. No. Pendent С плоской розеткой Aşağı bakan	Finish Покрытие Kaplama	H mm ["]	FM	UL
569381001	Red/Красн./Kırmızı	58.7 [2-5/16]	√	√
569389001	Zinc Chromate/Хромат цинка/Çinko kromat	58.7 [2-5/16]	√	√

G4 • TY-L & TY-FRL • 1/2" NPT & 3/4" NPT

Art. No. Pendent С плоской розеткой Aşağı bakan	Finish Покрытие Kaplama	H mm ["]	FM	UL
569371001	Red/Красн./Kırmızı	87.3 [3-7/16]	√	√
569379001	Zinc Chromate/Хромат цинка/Çinko kromat	87.3 [3-7/16]	√	√



TFP 780

0.120 kg

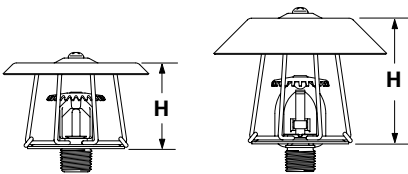

G1/S1 & G4/S4

G1/S1 • TY-B & TY-FRB • 1/2" NPT & 3/4" NPT

Art. No. Upright С вогнутой розеткой Yukarı bakan	Finish Покрытие Kaplama	H mm ["]	Ø mm ["]	UL
569381066	Red/Красн./Kırmızı	60.3 [2-3/8]	101.6 [4]	√
569389066	Zinc Chromate/Хромат цинка/Çinko kromat	60.3 [2-3/8]	101.6 [4]	√

G4/S4 • TY-L & TY-FRL • 1/2" NPT & 3/4" NPT

Art. No. Upright С вогнутой розеткой Yukarı bakan	Finish Покрытие Kaplama	H mm ["]	Ø mm ["]	UL
569371066	Red/Красн./Kırmızı	88.9 [3-1/2]	120.7 [4-3/4]	√
569379066	Zinc Chromate/Хромат цинка/Çinko kromat	88.9 [3-1/2]	120.7 [4-3/4]	√

TYCER TFP 03/07 Tyco reserves the right to change the contents without notice

RU Спринклерные аксессуары, спринклерные ограждения

TR Sprinkler aksesuarları, sprinkler korumaları



G2



TFP 782



0.08 kg

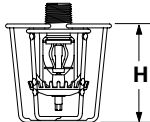

G2 • ELO-231 - ELO-231B & ELO-231FRB • 1/2" NPT & 3/4" NPT

Art. No. Pendent С плоской розеткой Aşağı bakan	Finish Покрытие Kaplama	H mm ["]	FM	UL
560001087	Red/Красн./Kırmızı	76.2 [3]	√	√
560001086	Zinc Chromate/Хромат цинка/Çinko kromat	76.2 [3]	√	√



WSG-2



TFP 782



0.200 kg

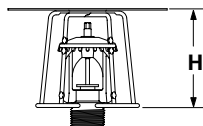

WSG-2 • ELO-231 - ELO-231B & ELO-231FRB • 1/2" NPT & 3/4" NPT

Art. No. Upright С вогнутой розеткой Yukarı bakan	Finish Покрытие Kaplama	H mm ["]	Ø mm ["]	UL
560001098	Red/Красн./Kırmızı	79.4 [3-1/8]	127 [5]	√
560001097	Zinc Chromate/Хромат цинка/Çinko kromat	79.4 [3-1/8]	127 [5]	√

TYCERTFP 03/07 Tyco reserves the right to change the contents without notice

RU Спринклерные аксессуары, спринклерные ограждения

TR Sprinkler aksesuarları, sprinkler korumaları



Kg 0.08 kg

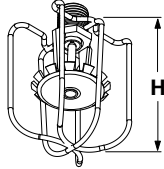

TYPE 011

Type 011 • TY-B & TY-FRB • 1/2" NPT & 3/4" NPT

Art. No. Pendent С плоской розеткой Aşağı bakan	Finish Покрытие Kaplama	H mm ["]
0110000	Red/Красн./Kırmızı	70 [2-3/4]
0110100	Zinc Chromate/Хромат цинка/Çinko kromat	70 [2-3/4]



Kg 0.08 kg

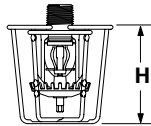

GUARD 2-SCREW

TY-B & TY-FRB • 1/2" NPT & 3/4" NPT

Art. No. Pendent С плоской розеткой Aşağı bakan	Finish Покрытие Kaplama	H mm ["]
55	Zinc Chromate/Хромат цинка/Çinko kromat	55 [2-1/6]
77	Zinc Chromate/Хромат цинка/Çinko kromat	77 [3]



Kg 0.15 kg

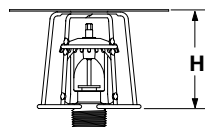

GUARD 2-SCREW

TY-B & TY-FRB • 1/2" NPT & 3/4" NPT

Art. No. Upright С вогнутой розеткой Yukarı bakan	Finish Покрытие Kaplama	Ø mm ["]	H mm ["]
55-B-160	Zinc Chromate/Хромат цинка/Çinko kromat	160 [6.1/3]	55 [2-1/6]
77-B-150	Zinc Chromate/Хромат цинка/Çinko kromat	150 [6]	77 [3]

TYCERTFP 03/07 Tyco reserves the right to change the contents without notice

RU Спринклерные аксессуары, спринклерные ограждения

TR Sprinkler aksesuarları, sprinkler korumaları



Kg 0.08 kg

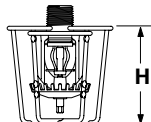

GU

Type GU • TY-B & TY-FRB • 1/2" NPT & 3/4" NPT

Art. No.
Pendent
С плоской розеткой
Aşağı bakan

Finish
Покрытие
Kaplama

H
mm ["]

GUMC

Zinc Chromate/Хромат цинка/Çinko kromat

55 [2-1/6]



Kg 0.15 kg

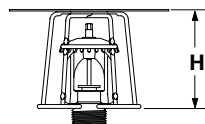

GU

Type GU • TY-B & TY-FRB • 1/2" NPT & 3/4" NPT

Art. No.
Upright
С вогнутой розеткой
Yukarı bakan

Finish
Покрытие
Kaplama

Ø
mm ["]

H
mm ["]

GUWSU

Zinc Chromate/Хромат цинка/Çinko kromat

93 [3.7]

55 [2-1/6]

Спринклерные аксессуары, спринклерные ключи Sprinkler aksesuarları, sprinkler anahtarları

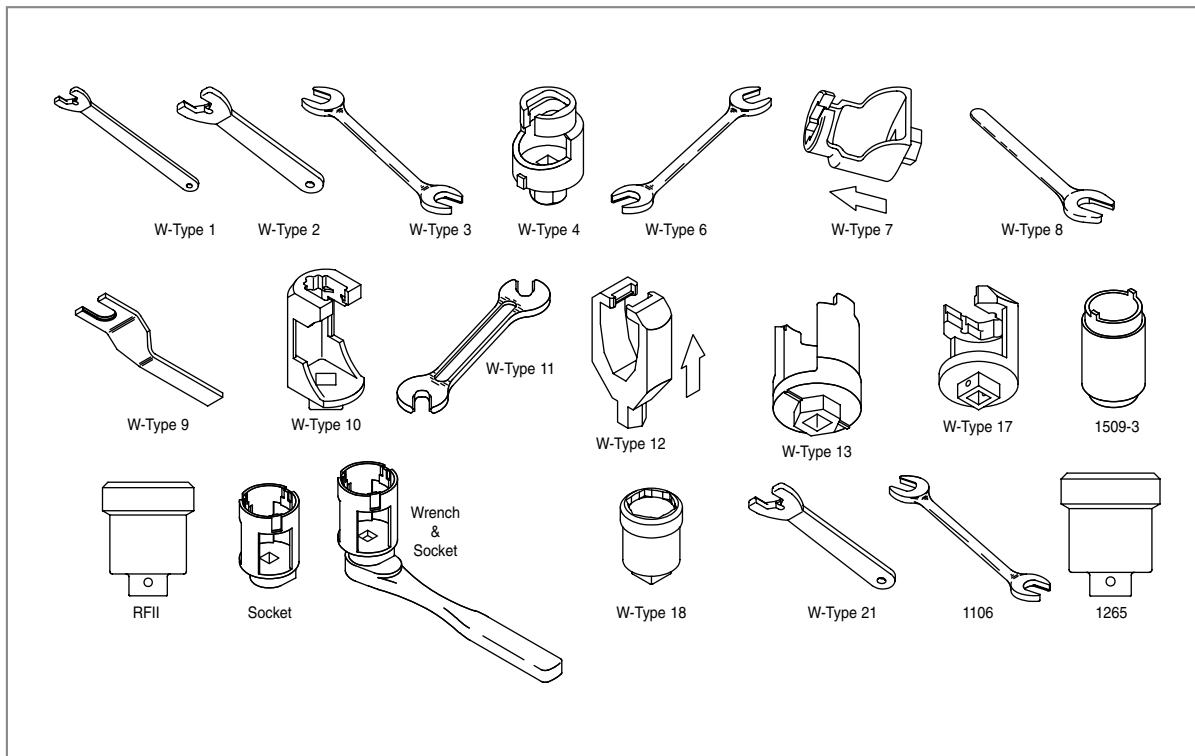

Art. No.	Wrench Type Тип ключа Anahtar tipi	Sprinkler Model
568721025	W-Type 1 Wrench	Model EC-25, Model ESFR-25
568721001	W-Type 2 Wrench	Model ESFR-1
568951001	W-Type 3 Wrench	Model BLVQ-QR, Series EC-14, Series EC-11, Model ELO SW-20 ECOH, Model ELO SW-24 ECOH, Model BV-20 QR, Model ELO-231 & ELO-231B, Model ELO-231 FRB, Model LD (Large Drop), Attic Series
568754001	W-Type 4 Wrench	Series EC-14, Series EC-11
560006387	W-Type 6 Wrench	Model TY-B, Model TY-FRB, Model SG, Model LF II, Model TY300-B Model TY300-FRB
568504001	W-Type 7 Wrench [Recessed]	Model TY-B, Model TY-FRB, Model SG, Model CHEC, Model LF II, Series DS-1, Model TY300-B, Model TY300-FRB
568921001	W-Type 8 Wrench	Model Ultra K17, Model K17-231
560001849	W-Type 9 Wrench	Model TY-L, Model TY-FRL, Model SGQR, Model SG
560001948	W-Type 10 Wrench	Model TY-L, Model SGQR
564521001	W-Type 11 Wrench	Series Issue "D" Quartzoid, Series Issue "D" Stainless Steel
567981001	W-Type 12 Wrench	Model TY-FRL
560104118	W-Type 17 Wrench	Series DS-2
560001265	W-Type 18 Wrench	Model LFII
560001092	W-Type 19 Wrench	Model TY-L Recessed
560001106	W-Type 20 Wrench	Model CC1
560010686	W-Type 21 Wrench	Model ESFR-17
1093	1093	Model BV-20 QR
1099	1099	Model BV-QR, Model BV-EC QR
1106	1106	Model BV-QR, Model A, Model H, Attic Series, Window (WS) Series, Model CC1
1122	1122	Model H
1265	1265	Model ELOC
560015093	1509-3 Institutional Wrench	Model TFP PH2, Model TFP PH5, Model TFP Max
560001075	RFII Wrench	Series RFII, Series DS-C, Series DS-CEC
560004947	Wrench (Socket Only)	Model LFII
560004948	Socket/Ratchet Wrench	Model LFII
560004300	Cover Removal Tool	Model LFII Protective Cover Removal Tool

TYCEGFFP-12/06 Tyco reserves the right to change the contents without notice

SOFTWARE FOR THE FIRE PROTECTION DESIGN PROFESSIONAL

SprinkCAD Pro II[®]

Complete Fire Sprinkler System Design Package

SprinkSLIC[™]

Complete Fire Sprinkler Stock Listing

SprinkCALC[™]

Advanced Hydraulic Calculations

SprinkFDT[™]

Fluid Delivery Time Calculations for Dry Systems

